

**AZ FLEX<sup>®</sup>**

# KATALÓG

TECHNICKÝCH  
IZOLÁCIÍ

02 / 2023

## IZOLÁCIE PRE TZB

- chladenie, kúrenie, vzduchotechnika

## IZOLÁCIE PRE PRIEMysel

- technológie od kryogeniky po žiarotechniku

## PROFESIONÁLNE IZOLAČNÉ SYSTÉMY

- izolačné materiály vysokej kvality
- pre médiá od -260°C do +1 430°C
- povrchové úpravy ochrany izolácie
- príslušenstvo k technickým izoláciám



**AZ FLEX, s.r.o.**  
Štrková 968/10C  
010 09 Žilina-Bytčica

- **web:** www.azflex.sk
- **IČO:** 36422851
- **IČ-DPH:** SK2021876032
- **Banka:** Československá obchodná banka, a.s. Žilina
- **SWIFT:** CEKOSKBX
- **Číslo účtu:** 4019665166/7500
- **IBAN:** SK83 7500 0000 0040 1966 5166
- **Výpis z OR:** Okresný súd Žilina, oddiel Sro, vložka č.15429/L



### PREDAJNÁ DOBA:

- PONDELOK – PIATOK:  
7:30 - 16:00 hod.

### ÚČTOVNÉ ODDELENIE:

- Mgr. Tatiana Adamcová  
☎ +421 911 944 296  
✉ azflex@azflex.sk

### PREVÁDZKA ŽILINA:

📍 AZ FLEX s.r.o.,  
Štrková 968/10C  
010 01 Žilina

#### Oddelenie odbytu

✉ zilina@azflex.sk  
Zuzana Kováčová  
☎ +421 910 944 298  
Marko Fondati  
☎ +421 910 944 297

#### Technické a obchodné oddelenie

✉ sustek@azflex.sk  
Marián Šustek  
☎ +421 911 944 297

### PREVÁDZKA KOŠICE:

📍 AZ FLEX s.r.o.,  
Rampová 5  
040 01 Košice

#### Oddelenie odbytu

✉ kosice@azflex.sk  
Peter Tivadar  
☎ +421 911 944 289  
Soňa Halászová  
☎ +421 915 110 040

#### Technické a obchodné oddelenie

✉ gladic@azflex.sk  
Miroslav Gladič  
☎ +421 911 944 288

### PREVÁDZKA BRATISLAVA:

📍 AZ FLEX s.r.o.,  
Staviteľská 7  
831 04 Bratislava

#### Oddelenie odbytu

✉ bratislava@azflex.sk  
Jaroslav Fečko  
☎ +421 911 944 294  
Andrej Tománek  
☎ +421 911 944 295

#### Technické a obchodné oddelenie

✉ sustek@azflex.sk  
Marián Šustek  
☎ +421 911 944 297



# TECHNICKÉ IZOLÁCIE - tepelné a chladové izolácie pre potrubné rozvody a zariadenia v budovách a priemysle

Verzia 2.0 - Cenník 02-2023. Platnosť od 1.2.2023 do vydania novej verzie cenníka

Technické izolácie	Strana	Typ izolácie	-	Formát (tvar)	max. teplota (orientačný údaj)									
					-50°C	15°C	65°C	90°C	150°C	250°C	500°C	1200°C		
<b>Armacell</b> - izolácie zo syntetického kaučuku (FEF)	4	Armaflex ULTIMA		závesy										
	5	Armafix ULTIMA		trubice, pásy										
	7,8,9	AF Armaflex		závesy										
	10	Armafix AF		trubice, pásy										
	11	NH Armaflex		trubice, pásy										
	12,13	Armaflex ACe, Armaflex ACe PLUS		trubice, pásy										
	14	Armaflex DUCT AL		pásy										
	15	Arma-Chek Silver		trubice, pásy										
	16	HT Armaflex		trubice, pásy										
17	HT Armaflex S		trubice, pásy											
-	18	Izol. závesy RF s kovovou objímkou		závesy										
<b>Kaimann</b> - izolácie zo syntetického kaučuku (FEF)	19	Kaiflex RT ST		závesy										
	20,21,23	Kaiflex ST		trubice, pásy										
	24,25	Kaiflex EF		trubice, pásy										
	26	Kaiflex DUCT		pásy										
	27	Kaiflex Protect ALU TEC		trubice, pásy										
	28	Kaiflex EPDM		trubice, pásy										
<b>Izolácie z Polyetylénu (PE)</b>	29	Tubolit S, Tubolit S+		trubice										
	30	Tubolit DG		trubice										
	31	AR Fonoblok, ARW Fonowave		hadice										
	32	Mirelon Polar		trubice										
	33	Mirelon Stabil		trubice										
	34	PE pásy (Mirelon, Izoflex)		pásy										
<b>Protihlukové izolácie</b>	35	Trocellen APLOMB		pásy										
	37	ArmaComfort		pásy										
	38	Kaisound		pásy										
	39	Kaivenience		pásy										
<b>Isover</b> - izolácie z minerálnej vlny	40	Climcover, Ventilam ALU/ML3, ML3 PLUS		pásy										
	40	Orstech LSP 40, LSP H , LSP PYRO		pásy										
	40,41	Isover TECH Wired Mat		rohože										
	41	Orstech 45,65,90,110 kg/m3		dosky										
	43	PYRO EI 30,45, 60min.		dosky, pásy										
	43	U Protect EI 30,45,60,90,120min.		dosky, rohože										
	45	CLIMAVER		dosky										

Technické izolácie	Strana	-	Formát (tvar)	-50°C	15°C	65°C	90°C	150°C	250°C	500°C	1200°C
<b>Paroc</b> <i>- izolácie z minerálnej vlny</i>	46	Paroc HVAC COMBI AluCoat T	skruže								
	46,47,49	Paroc HVAC Section ALuCoat T	skruže								
	50	Paroc HVAC Lamella Mat AluCoat	pásky								
	50	Paroc HVAC slab, INVENT	dosky								
	51	Paroc PRO Lamella Mat AluCoat	pásky								
	51	Paroc PRO Mat AluCoat, Paroc PRO Mat	rohože								
	51	Paroc PRO Wired Mat	rohože								
<b>Rockwool</b> <i>- izolácie z minerálnej vlny</i>	53	Rockwool 800	skruže								
	54	Klimafix	pásky								
	54	Larock 40	pásky								
	54	Techrock ALS, Techrock FB1	dosky								
	55	Pyrorock EI 30,45,60min.	dosky, pásky	Protipožiarna ochrana VZT							
	55	Conlit Ductrock EI 30,60,90,120min.	dosky	Protipožiarna ochrana VZT							
	56	Rockwool TECLIT	skruže								
	58,59	ProRox PS 960	skruže								
	60	ProRox LM 930 ALU, ProRox MA 520 ALU, LF970	pásky								
	60	ProRox WM 920, 950, 960, 970	rohože								
	61	ProRox SL	dosky								
<b>Požiarová ochrana, žiaruvzdor. izolácie</b>	63	Promatec AD, Promatec L500, EI 30,45,60,90,120 min.	dosky	Protipožiarna ochrana VZT							
	64	Žiaruvzdorné rohože, dosky, papier	dosky, rohože								
<b>Snímacie izolácie</b>	65	TEMKET	tvarovky								
<b>Nanoizolácie</b>	66	Armagel									
<b>Systémy povrchových úprav -interiér</b>	68,69	Fólia PVC Ekafol / Isogenopak	fólia, tvarovky								
	70	Fólia PVC Ekatec / Isogenotec	fólia, tvarovky								
	71	Fólia AL Ekamat (Okatherm)	fólia, tvarovky								
<b>Príslušenstvo</b>	72,73	Doplňky EKAFIX - pre PVC povrchy a AL fóliu Ekamat	príslušenstvo								
<b>Systémy povrchových úprav -exteriér</b>	74-80	Oplechovanie Ekamet (Okabell) a príslušenstvo	tvarovky								
	81	Fólia Anticor Clad, Tembutil IF, Flexipane	fólia								
<b>Príslušenstvo</b>	82	ARMACELL (Armaflex)	príslušenstvo								
	83	KAIMANN (Kaiflex)	príslušenstvo								
	84	AZ FLEX - náradie a montážne pomôcky	príslušenstvo								
	85	Kotviaca technika	príslušenstvo								
	86,87	Samolepiace pásky a fólie do výkopov	príslušenstvo								
	88	Špeciálne aplikácie TEMATI	príslušenstvo								
-	89-95	Pomocné tabuľky									

## TRUBICE ARMAFLEX ULTIMA



Syntetický kaučuk (elastomer) vyrobený technológiou Armaprene s vylepšenými vlastnosťami, ktoré spomaľujú horenie a znižujú tvorbu dymu. Použitie pre teploty od -50°C(-200°C) do +110°C. Dĺžka trubice 2m. Faktor difúzneho odporu  $\mu > 7\ 000$ . Súčiniteľ tepelnej vodivosti  $\lambda 0\ ^\circ\text{C} = 0,040\ \text{W/m.K}$ . Trieda reakcie na oheň BL-s1, d0 (dosky BL-s2, d0)

Vonk. Ø potr. (mm)	Armaflex ULTIMA			Armaflex ULTIMA			Armaflex ULTIMA			Armaflex ULTIMA		
	Hr. izolácie 9 mm			Hr. izolácie 13 mm			Hr. izolácie 19 mm			Hr. izolácie 25 mm		
	Obj. kód	bm/ bal.	EUR/bm bez DPH	Obj. kód	bm/ bal.	EUR/bm bez DPH	Obj. kód	bm/ bal.	EUR/bm bez DPH	Obj. kód	bm/ bal.	EUR/bm bez DPH
12	UD 012 / 9	192	22,25 €	UD 012 / 13	130	23,40 €						
15	UD 015 / 9	180	22,45 €	UD 015 / 13	112	24,65 €	UD 015 / 19	64	45,45 €			
18	UD 018 / 9	150	22,70 €	UD 018 / 13	98	26,70 €	UD 018 / 19	58	46,35 €	UD 018 / 25	46	66,85 €
22	UD 022 / 9	124	23,90 €	UD 022 / 13	88	27,75 €	UD 022 / 19	56	52,90 €	UD 022 / 25	36	75,00 €
28	UD 028 / 9	96	24,90 €	UD 028 / 13	64	30,25 €	UD 028 / 19	40	56,95 €	UD 028 / 25	36	77,25 €
35	UD 035 / 9	70	28,45 €	UD 035 / 13	56	33,75 €	UD 035 / 19	40	61,90 €	UD 035 / 25	28	84,00 €
42	UD 042 / 9	56	30,65 €	UD 042 / 13	48	40,95 €	UD 042 / 19	24	72,30 €	UD 042 / 25	24	93,75 €
48	UD 048 / 9	52	33,10 €	UD 048 / 13	40	43,40 €	UD 048 / 19	24	73,90 €	UD 048 / 25	20	102,90 €
54	UD 054 / 9	42	35,80 €	UD 054 / 13	36	47,65 €	UD 054 / 19	24	98,15 €	UD 054 / 25	18	108,35 €
60	UD 060 / 9	40	39,95 €	UD 060 / 13	28	54,15 €	UD 060 / 19	16	109,50 €	UD 060 / 25	18	121,65 €
64	UD 064 / 9	28	46,80 €	UD 064 / 13	26	60,50 €	UD 064 / 19	16	118,80 €	UD 064 / 25	16	153,60 €
76	UD 076 / 9	32	50,60 €	UD 076 / 13	24	67,55 €	UD 076 / 19	16	120,90 €	UD 076 / 25	12	176,35 €
89	UD 089 / 9	24	54,25 €	UD 089 / 13	18	77,00 €	UD 089 / 19	16	129,30 €	UD 089 / 25	12	189,30 €

## PÁSY ARMAFLEX ULTIMA

Izolačné pásy zo syntetického kaučuku.

Armaflex ULTIMA			
Hr. izol. (mm)	Rola (šírka 1m) Obj.kód	m <sup>2</sup> / bal.	EUR/m <sup>2</sup> bez DPH
6	UD 06 -99 -E	15	106,15 €
9	UD 09 -99 -E	10	161,45 €
13	UD 13 -99 -E	8	228,40 €
19	UD 19 -99 -E	5	315,30 €
25	UD 25 -99 -E	4	397,40 €
32	UD 32 -99 -E	3	443,95 €

Samolepiace pásy zo syntetického kaučuku

Armaflex ULTIMA (A) samolep			
Hr izol (mm)	Rola (šírka 1m) Obj.kód	m <sup>2</sup> / bal.	EUR/m <sup>2</sup> bez DPH
6	UD 06 -99 -EA	15	140,60 €
9	UD 09 -99 -EA	10	186,95 €
13	UD 13 -99 -EA	8	249,95 €
19	UD 19 -99 -EA	5	335,75 €
25	UD 25 -99 -EA	4	415,35 €
32	UD 32 -99 -EA	3	469,50 €

## ZÁVESY ARMAFIX ULTIMA



Chladové izolačné závesy do systému Armaflex ULTIMA.

Použitie pre teploty od -50°C do +110°C.

Objemohá hmotnosť 95-105kg/m<sup>3</sup>. Súčiniteľ tepelnej vodivosti  $\lambda$  0 °C = 0,040 W/m.K.

Trieda reakcie na oheň v systéme Armaflex ULTIMA BL-s1, d0 (dosky BL-s2, d0).

Vonk. Ø potr. (mm)	Armafix ULTIMA					Armafix ULTIMA					Armafix ULTIMA				
	Hr. izolácie 13 mm					Hr. izolácie 19mm					Hr. izolácie 25mm				
	Vzdialenosť závesov (m)	Vonkajší Ø závesov	Obj. kód	ks/bal.	EUR/ks bez DPH	Vzdialenosť závesov (m)	Vonkajší Ø závesov	Obj. kód	ks/bal.	EUR/ks bez DPH	Vzdialenosť závesov (m)	Vonkajší Ø závesov	Obj. kód	ks/bal.	EUR/ks bez DPH
12	2	38	ULP 13 10/12	32	14,20 €	2	50	ULP 19 10/12	28	15,90 €					
18	2	44	ULP 13 15/18	32	14,45 €	2	56	ULP 19 15/18	28	16,25 €	2,25	68	ULP 25 15/18	28	21,75 €
22	2,75	48	ULP 13 22/25	32	16,35 €	2,75	60	ULP 19 22/25	28	17,85 €	2,75	72	ULP 25 22/25	28	23,70 €
28	3	54	ULP 13 28/30	32	18,35 €	3	66	ULP 19 28/30	28	21,00 €	3	78	ULP 25 28/30	28	26,95 €
35	3,5	61	ULP 13 35/38	28	19,85 €	3,5	73	ULP 19 35/38	24	23,10 €	3,5	85	ULP 25 35/38	24	30,75 €
42	3,75	68	ULP 13 42/45	28	20,10 €	3,75	80	ULP 19 42/45	24	23,55 €	3,75	92	ULP 25 42/45	24	32,40 €
48	4,25	74	ULP 13 48	28	21,10 €	4,25	86	ULP 19 48	24	24,50 €	4,25	98	ULP 25 48	24	35,10 €
54	4,25	80	ULP 13 54/57	28	21,65 €	4,25	92	ULP 19 54/57	24	25,65 €	4,25	104	ULP 25 54/57	24	36,80 €
60	4,75	86	ULP 13 60/64	24	26,95 €	4,75	98	ULP 19 60/64	20	31,60 €	4,75	110	ULP 25 60/64	20	45,45 €
76	5,5	102	ULP 13 76/80	20	29,55 €	5,5	114	ULP 19 76/80	16	37,05 €	5,5	126	ULP 25 76/80	16	53,45 €
89	6	117	ULP 13 89	16	34,25 €	6	129	ULP 19 89	12	44,15 €	6	141	ULP 25 89	12	63,30 €
110						6	150	ULP 19 102/108	12	55,60 €					
114						6	154	ULP 19 110/114	12	65,60 €					
133						6	173	ULP 19 133/140	12	78,70 €	6	185	ULP 25 133/140	12	79,75 €
160											6	214	ULP 25 160	6	90,95 €
168						6	210	ULP 19 165/168	6	91,30 €	6	222	ULP 25 165/168	6	103,65 €
180						6	222	ULP 19 180	4	120,50 €					
200						6	242	ULP 19 204	4	132,55 €	6	254	ULP 25 204	1	144,10 €
219						6	261	ULP 19 216/219	4	145,80 €	6	273	ULP 25 216/219	4	164,25 €
254						6	296	ULP 19 254	3	160,35 €	6	308	ULP 25 254	3	187,20 €
267						6	309	ULP 19 267/273	3	176,40 €	6	321	ULP 25 267/273	3	195,65 €
306											6	360	ULP 25 306	1	213,45 €
324											4,5	378	ULP 25 324	1	243,30 €
356						4,2	398	ULP 19 356	1	220,05 €	4,2	410	ULP 25 356	3	277,35 €
406											4,2	460	ULP 25 406	3	316,20 €
457											3,7	511	ULP 25 457	4	360,50 €

Dodávané bez kovovej objímky.

# AF/Armaflex®

PRUŽNÝ IZOLAČNÝ SYSTÉM PRE  
SPOĽHLIVÚ KONTROLU  
KONDENZÁCIE, NA KTORÝ SA  
MÔŽETE SPOĽAHNÚŤ UŽ 40 ROKOV

# Armafix® AF

ZÁVESNÝ SYSTÉM POTRUBIA  
PRE AF/ARMAFLEX®, KTORÝ  
UMOŽŇUJE RÝCHLU MONTÁŽ  
A ZABRAŇUJE VZNIKU KONDENZÁCIE



- Integrovaná bariéra vodných pár znižuje riziko korózie pod izoláciou.
- Ak je inštalácia izolácie vykonaná autorizovanou izolačnou spoločnosťou a ak boli použité prvky AF Armafix a lepidlo, je zaistená najvyššia úroveň spoľahlivosti systému.
- Stabilná tepelná vodivosť zaručuje dlhodobú úsporu energie.
- Integrovaná antibakteriálna ochrana Microban® znižuje rast hniloby a baktérií.
- Eurotrieda B/BL-s3, d0.
- Schválené FM a UL.



- Eurotrieda B / BL-s3, d0
- Pri použití s výrobkom AF/Armaflex vysoká odolnosť proti difúzii vodných pár ( $\mu$  10 000).
- Vysoká mechanická odolnosť inštalácie potrubia pri malom počte závesov.
- Menej položiek na sklade, vhodné pre viac potrubných priemerov.
- Jednoduché lepenie vďaka samolepiacemu uzáveru.
- Zabudovaná parozábrana zabraňuje vzniku tepelných mostov a znižuje riziko kondenzácie.



Syntetický kaučuk (elastomer) čiernej farby, pre teploty od -50°C(-200°C) do +110°C. Vysoko ohybný izolačný materiál so štruktúrou uzavretých buniek, vysokým odporom proti difúzii vodnej pary a nízkou tepelnou vodivosťou. Dĺžka 2m. Faktor difúzneho odporu

Vonk. Ø potr.	Armaflex AF1				Armaflex AF2				Armaflex AF3			
	Hr. izolácie 7,5 mm až 10 mm				Hr. izolácie 11 mm až 16 mm				Hr. izolácie 13 mm až 19 mm			
	Hr. izol.	Obj. kód	bm/bal.	EUR/bm bez DPH	Hr. izol.	Obj. kód	bm/bal.	EUR/bm bez DPH	Hr. izol.	Obj. kód	bm/bal.	EUR/bm bez DPH
6	7,0	AF1 006	360	2,55 €	9,5	AF2 006	288	3,40 €				
8	7,0	AF1 008	310	2,60 €	10,0	AF2 008	240	3,60 €				
10	7,5	AF1 010	284	2,75 €	11,0	AF2 010	170	3,90 €	12,5	AF3 010	156	5,90 €
12	7,5	AF1 012	234	2,90 €	11,0	AF2 012	168	4,10 €	13,0	AF3 012	144	6,25 €
15	8,0	AF1 015	192	3,05 €	11,5	AF2 015	130	4,65 €	14,0	AF3 015	108	7,45 €
18	8,0	AF1 018	140	3,25 €	11,5	AF2 018	120	5,00 €	14,0	AF3 018	96	7,75 €
22	8,5	AF1 022	132	3,60 €	12,0	AF2 022	100	5,45 €	14,5	AF3 022	84	8,75 €
25	8,5	AF1 025	108	3,85 €	12,5	AF2 025	84	5,60 €				
28	8,5	AF1 028	100	4,00 €	12,5	AF2 028	84	5,85 €	15,5	AF3 028	64	10,30 €
30	9,0	AF1 030	96	4,25 €	12,5	AF2 030	72	6,45 €				
35	9,0	AF1 035	76	4,55 €	13,0	AF2 035	62	7,20 €	16,0	AF3 035	46	12,00 €
38	9,0	AF1 038	70	4,75 €								
42	9,0	AF1 042	60	5,20 €	13,5	AF2 042	48	7,95 €	16,5	AF3 042	40	13,50 €
45	9,0	AF1 045	56	5,65 €								
48	9,0	AF1 048	50	6,00 €	13,5	AF2 048	44	9,55 €	16,5	AF3 048	32	16,45 €
54	9,0	AF1 054	48	7,05 €	13,5	AF2 054	36	11,60 €	17,0	AF3 054	28	18,80 €
57	9,0	AF1 057	40	7,80 €	14,0	AF2 057	34	12,25 €				
60	9,0	AF1 060	36	8,75 €	14,0	AF2 060	32	12,60 €	17,0	AF3 060	24	20,90 €
64	9,5	AF1 064	32	9,75 €	14,0	AF2 064	30	13,05 €	17,0	AF3 064	20	22,15 €
70	9,5	AF1 070	32	10,70 €	14,0	AF2 070	28	14,80 €	17,5	AF3 070	18	23,95 €
76	9,5	AF1 076	28	11,70 €	14,0	AF2 076	28	15,85 €	17,5	AF3 076	16	25,85 €
80	9,5	AF1 080	24	12,85 €	14,5	AF2 080	24	17,40 €				
89	9,5	AF1 089	22	14,15 €	14,5	AF2 089	22	18,90 €	18,0	AF3 089	16	29,10 €
102	9,5	AF1 102	16	19,55 €	14,5	AF2 102	18	24,80 €				
108	9,5	AF1 108	16	21,40 €	14,5	AF2 108	18	27,00 €	18,0	AF3 108	12	40,45 €
114	9,5	AF1 114	16	23,00 €	15,0	AF2 114	16	29,55 €	18,5	AF3 114	12	42,60 €
125	9,5	AF1 125	12	36,15 €	15,0	AF2 125	12	36,40 €	18,5	AF3 125	12	48,95 €
133					15,5	AF2 133	12	38,15 €	18,5	AF3 133	8	50,90 €
140	10,0	AF1 140	12	32,30 €	15,5	AF2 140	8	39,30 €	19,0	AF3 140	8	53,55 €
160	10,0	AF1 160	8	44,25 €	16,0	AF2 160	8	45,95 €	19,0	AF3 160	6	61,65 €

# TRUBICE AF ARMAFLEX



Vonk. Ø potr. (mm)	Armaflex AF4				Armaflex AF 5				Armaflex AF 6			
	Hr. izolácie 16 mm až 25 mm				Hr. izolácie 25 mm až 32 mm				Hr. izolácie 32 mm až 45 mm			
	Hr. izol.	Obj. kód	bm/ bal.	EUR/bm bez DPH	Hr. izol.	Obj. kód	bm/ bal.	EUR/bm bez DPH	Hr. izol.	Obj. kód	bm/ bal.	EUR/bm bez DPH
10	15,5	AF4 010	110	6,65 €					32,0	AF6 010	40	15,20 €
12	16,0	AF4 012	100	7,05 €					32,0	AF6 012	36	15,85 €
15	17,0	AF4 015	88	8,50 €					32,0	AF6 015	32	16,50 €
18	17,5	AF4 018	70	8,75 €	25,0	AF5 018	42	12,85 €	32,0	AF6 018	32	17,55 €
22	18,0	AF4 022	60	9,95 €	25,0	AF5 022	36	13,60 €	33,5	AF6 022	28	18,65 €
25	18,0	AF4 025	56	11,65 €								
28	19,0	AF4 028	48	11,90 €	25,0	AF5 028	36	15,95 €	35,0	AF6 028	24	20,65 €
30	19,0	AF4 030	40	12,25 €								
35	19,5	AF4 035	36	13,75 €	27,0	AF5 035	24	17,50 €	35,0	AF6 035	18	24,00 €
42	20,5	AF4 042	32	15,55 €	27,0	AF5 042	22	21,90 €	36,5	AF6 042	16	29,90 €
45	20,5	AF4 045	28	17,25 €								
48	21,0	AF4 048	24	18,95 €	27,5	AF5 048	16	25,60 €	37,5	AF6 048	12	32,40 €
54	21,0	AF4 054	24	21,45 €	28,5	AF5 054	16	28,95 €	38,0	AF6 054	12	40,00 €
57	21,5	AF4 057	20	23,40 €					38,5	AF6 057	12	40,15 €
60	21,5	AF4 060	20	24,00 €	29,0	AF5 060	12	31,45 €	39,0	AF6 060	10	40,40 €
64	21,5	AF4 064	18	25,50 €	29,0	AF5 064	12	33,15 €	39,5	AF6 064	10	42,30 €
67	22,0	AF4 067	16	27,25 €	29,0	AF5 070	12	34,90 €	40,0	AF6 070	8	45,80 €
76	22,0	AF4 076	16	29,50 €	30,0	AF5 076	10	37,20 €	40,5	AF6 076	8	48,10 €
80	22,5	AF4 080	16	31,55 €								
89	22,5	AF4 089	12	32,70 €	30,5	AF5 089	8	41,25 €	41,5	AF6 089	6	53,30 €
102	23,0	AF4 102	10	42,70 €					42,5	AF6 102	4	61,45 €
108	23,5	AF4 108	10	45,20 €	31,0	AF5 108	6	56,95 €	42,5	AF6 108	4	72,35 €
114	23,5	AF4 114	10	47,65 €	31,5	AF5 114	6	60,05 €	43,0	AF6 114	4	77,85 €
125	23,5	AF4 125	8	53,00 €								
133	24,0	AF4 133	6	55,05 €					44,0	AF6 133 **	4	91,00 €
140	24,5	AF4 140	6	58,30 €	32,0	AF5 140 **	6	73,50 €	44,5	AF6 140 **	4	96,60 €
160	25,0	AF4 160	6	66,85 €					45,0	AF6 160 **	4	112,65 €

\*\* - dĺžka trubice 1m.



## TRUBICE samolep AF ARMAFLEX



Syntetický kaučuk (elastomer) čiernej farby, pre teploty od -50°C(-200°C) do +110°C.  
 Vysoko ohybný izolačný materiál so štruktúrou uzavretých buniek, vysokým odporom proti difúzii vodnej pary a nízkou tepelnou vodivosťou.  
 Dĺžka samolepiacej trubice 2m. Faktor difúzneho odporu  $\mu > 10\ 000$ . Súčiniteľ tepelnej vodivosti  $\lambda 0\ ^\circ\text{C} = 0,033\ \text{W/m.K}$ .  
 Trieda reakcie na oheň BL-s3, d0.

Vonk. Ø potr. (mm)	Armaflex AF1 (A)				Armaflex AF2 (A)				Armaflex AF3 (A)				Armaflex AF4 (A)			
	Hr. izolácie 7,5 mm až 10 mm				Hr. izolácie 11 mm až 16 mm				Hr. izolácie 13 mm až 19 mm				Hr. izolácie 16 mm až 25 mm			
	Hr. izol.	Obj. kód	bm/bal.	EUR/bm bez DPH	Hr. izol.	Obj. kód	bm/bal.	EUR/bm bez DPH	Hr. izol.	Obj. kód	bm/bal.	EUR/bm bez DPH	Hr. izol.	Obj. kód	bm/bal.	EUR/bm bez DPH
15	8,0	AF1 015 -A	192	4,05 €	11,5	AF2 015 -A	124	6,00 €	14,0	AF3 015 -A	108	9,05 €	17,0	AF4 015 -A	80	10,15 €
18	8,0	AF1 018 -A	140	4,35 €	11,5	AF2 018 -A	120	6,35 €	14,0	AF3 018 -A	96	9,40 €	17,5	AF4 018 -A	60	10,50 €
22	8,5	AF1 022 -A	132	4,75 €	12,0	AF2 022 -A	96	6,80 €	14,5	AF3 022 -A	84	10,40 €	18,0	AF4 022 -A	56	11,70 €
28	8,5	AF1 028 -A	100	5,20 €	12,5	AF2 028 -A	80	7,30 €	15,5	AF3 028 -A	60	11,95 €	19,0	AF4 028 -A	48	13,70 €
35	9,0	AF1 035 -A	70	5,70 €	13,0	AF2 035 -A	60	8,55 €	16,0	AF3 035 -A	40	13,70 €	19,5	AF4 035 -A	36	15,60 €
42	9,0	AF1 042 -A	60	6,40 €	13,5	AF2 042 -A	40	9,45 €	16,5	AF3 042 -A	40	15,30 €	20,5	AF4 042 -A	32	17,40 €
48	9,0	AF1 048 -A	50	7,25 €	13,5	AF2 048 -A	40	11,10 €	16,5	AF3 048 -A	32	18,25 €	21,0	AF4 048 -A	24	20,90 €
54	9,0	AF1 054 -A	40	8,30 €	13,5	AF2 054 -A	32	13,00 €	17,0	AF3 054 -A	24	20,65 €	21,0	AF4 054 -A	24	23,40 €
60	9,0	AF1 060 -A	36	10,10 €	14,0	AF2 060 -A	32	14,20 €	17,0	AF3 060 -A	24	22,85 €	21,5	AF4 060 -A	20	26,00 €
76	9,5	AF1 076 -A	24	12,95 €	14,0	AF2 076 -A	28	17,45 €	17,5	AF3 076 -A	16	27,95 €	22,0	AF4 076 -A	16	31,40 €
89	9,5	AF1 089 -A	20	15,40 €	14,5	AF2 089 -A	20	19,80 €	18,0	AF3 089 -A	16	31,35 €	22,5	AF4 089 -A	12	35,25 €

## PÁSY AF ARMAFLEX

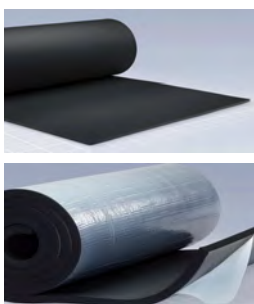

Pásky zo syntetického kaučuku.

AF Armaflex			
Hr. izol. (mm)	Rola (šírka 1m) Obj.kód	m <sup>2</sup> /bal.	EUR/m <sup>2</sup> bez DPH
3	-	-	-
6	-	-	-
10	AF 10MM -E	10	36,80 €
13	AF 13MM -E	8	37,55 €
16	AF 16MM -E	7	48,25 €
19	AF 19MM -E	6	58,05 €
25	AF 25MM -E	4	72,25 €
32	AF 32MM -E	3	90,10 €
50	AF 50MM -E	5	114,25 €

Samolepiace pásky zo syntetického kaučuku

AF Armaflex (A) samolep			
Hr. izol. (mm)	Rola (šírka 1m) Obj.kód	m <sup>2</sup> /bal.	EUR/m <sup>2</sup> bez DPH
3	AF 03MM -EA	30	30,15 €
6	AF 06MM -EA	15	36,80 €
10	AF 10MM -EA	10	46,85 €
13	AF 13MM -EA	8	52,80 €
16	AF 16MM -EA	7	63,55 €
19	AF 19MM -EA	6	73,40 €
25	AF 25MM -EA	4	86,95 €
32	AF 32MM -EA	3	105,55 €



Chladové objímky. Závesné systémy pre rozvody chladu alebo klimatizácie bez tepelných mostov.

Vonk. Ø potrubia (mm)	Armafix FX 2					Armafix FX 4					Armafix FX 6				
	Hr. izolácie 11 mm až 16 mm					Hr. izolácie 16mm až 25 mm					Hr. izolácie 32 mm až 45mm				
	Vzdialenosť závesov (m)	Vonkajší Ø závesov	Obj. kód	ks/bal.	EUR/ks bez DPH	Vzdialenosť závesov (m)	Vonkajší Ø závesov	Obj. kód	ks/bal.	EUR/ks bez DPH	Vzdialenosť závesov (m)	Vonkajší Ø závesov	Obj. kód	ks/bal.	EUR/ks bez DPH
12	2	38	FX2 10/12	32	4,75 €	2	50	FX4(3) 10/12	28	5,30 €					
18	2,25	43	FX2 15/18	32	4,85 €	2,25	55	FX4(3) 15/18	28	5,45 €	2,25	77	FX6 15/18	20	7,30 €
22	2,75	47	FX2 22/25	32	5,45 €	2,75	60	FX4(3) 22/25	28	6,00 €	2,75	80	FX6 22/25	20	8,05 €
28	3	53	FX2 28/30	32	6,20 €	3	66	FX4(3) 28/30	28	7,00 €	3	91	FX6 28/30	20	9,25 €
35	3,5	61	FX2 35/38	28	6,70 €	3,5	74	FX4(3) 35/38	24	7,80 €	3,5	104	FX6 35/38	16	10,55 €
42	3,75	69	FX2 42/45	28	6,85 €	3,75	85	FX4(3) 42/45	24	7,90 €	3,75	113	FX6 42/45	16	11,10 €
48	4,25	76	FX2 48	28	7,20 €	4,25	91	FX4(3) 48	24	8,35 €	4,25	119	FX6 48	16	12,00 €
54	4,25	82	FX2 54/57	28	7,40 €	4,25	98	FX4(3) 54/57	24	8,80 €	4,25	126	FX6 54/57	16	12,55 €
60	4,75	89	FX2 60/64	24	9,25 €	4,75	105	FX4(3) 60/64	20	10,80 €	4,75	134	FX6 60/64	12	15,50 €
70	4,75	99	FX2 70		9,85 €	4,75	115	FX4(3) 70		11,40 €	4,75	140	FX6 70		16,75 €
76	5,5	105	FX2 76/80	20	10,05 €	5,5	122	FX4(3) 76/80	16	12,65 €	5,5	152	FX6 76/80	12	18,25 €
89	6	118	FX2 89	16	11,75 €	6	136	FX4(3) 89	12	15,10 €	6	167	FX6 89	12	21,65 €
108	6	141	FX2 102/108	16	13,90 €	6	156	FX4(3) 102/108	12	16,30 €	6	179	FX6 102/108	12	23,75 €
114	6	144	FX2 114	12	15,80 €	6	162	FX4(3) 114	12	18,50 €	6	188	FX6 102/108	12	28,20 €
125	6	158	FX2 125	12	16,50 €	6	173	FX4(3) 125	12	20,10 €	6	196	FX6 114	12	29,95 €
133	6	165	FX2 133/140	12	17,95 €	6	183	FX4(3) 133/140	12	21,65 €	6	219	FX6 133/140	8	34,05 €
160	6	193	FX2 160	9	20,10 €	6	210	FX4(3) 160	6	25,15 €	6	248	FX6 160	6	46,00 €
168	6		FX2 168	10	21,75 €	6	216	FX4(3) 165/168	6	27,35 €	6	254	FX6 165/168	5	48,40 €
200						6	255	FX4(3) 204	4	100,45 €	6	305	FX6 204	3	125,70 €
219						6	267	FX4(3) 216/219	4	94,55 €	6	317	FX6 216/219	1	97,30 €
254						6		FX4(3) 254		113,25 €	6	355	FX6 254	1	145,65 €
267						6	318	FX4(3) 267/273	3	124,65 €	6	368	FX6 267/273	1	120,20 €
306						6	357	FX4(3) 306	1	145,50 €	6	407	FX6 306	6	173,20 €
324						4,5	375	FX4(3) 324	1	154,45 €	4,5	425	FX6 324	6	189,55 €
356						4,2	407	FX4(3) 356	6	164,10 €	4,2	457	FX6 356	6	199,10 €
406						4,2	457	FX4(3) 406	6	179,55 €	4,2	507	FX6 406	2	220,55 €
457						3,7	508	FX4(3) 457	4	194,55 €	3,7	558	FX6 457	2	247,65 €
508						3,4	559	FX4(3) 508	4	219,20 €	3,4	609	FX6 508	2	275,25 €
610						2,9	661	FX4(3) 610	2	246,30 €	2,9	711	FX6 610	2	312,45 €

Dodávané bez kovovej objímky

## TRUBICE NH ARMAFLEX



Syntetický kaučuk (elastomer) šedej farby, pre teploty od -50°C do +115°C. Vysoko ohybný ekologický izolačný materiál so štruktúrou uzavretých buniek. Neobsahuje žiadne samozhášavé prísady na báze halogénov. V prípade požiaru dochádza k obmedzeniu vzniku toxických spodín a zníženiu hustoty dymu. Izolácia je vhodná pre použitie do čistých priestorov, serverovní, v námornom priemysle a pod.

Faktor difúzneho odporu  $\mu > 7000$ . Súčiniteľ tepelnej vodivosti  $\lambda_{0^\circ\text{C}} = 0,040 \text{ W/m.K}$ . Dĺžka trubice 2m. Trieda reakcie na oheň D-s3, d0.

Vonk. Ø potr. (mm)	NH Armaflex			NH Armaflex			NH Armaflex			NH Armaflex		
	Hr. izolácie 9 mm			Hr. izolácie 13 mm			Hr. izolácie 19 mm			Hr. izolácie 25 mm		
	Obj. kód	bm/ bal.	EUR/bm bez DPH	Obj. kód	bm/ bal.	EUR/bm bez DPH	Obj. kód	bm/ bal.	EUR/bm bez DPH	Obj. kód	bm/ bal.	EUR/bm bez DPH
10	010 / 9	266	4,50 €	010 / 13	156	6,15 €						
12	012 / 9	200	4,80 €	012 / 13	162	6,60 €						
15	015 / 9	192	5,00 €	015 / 13	120	7,35 €	015 / 19	78	13,35 €			
18	018 / 9	166	5,30 €	018 / 13	112	7,95 €	018 / 19	60	13,80 €			
22	022 / 9	136	5,90 €	022 / 13	98	8,65 €	022 / 19	56	16,00 €	022 / 25	40	31,45 €
28	028 / 9	98	6,60 €	028 / 13	78	9,35 €	028 / 19	48	18,75 €	028 / 25	32	36,95 €
35	035 / 9	76	7,45 €	035 / 13	56	11,35 €	035 / 19	36	21,70 €	035 / 25	24	43,15 €
42	042 / 9	60	8,45 €	042 / 13	48	12,70 €	042 / 19	32	24,55 €	042 / 25	22	48,55 €
48	048 / 9	50	9,80 €	048 / 13	40	15,25 €	048 / 19	24	29,90 €	048 / 25	18	56,30 €
54				054 / 13	34	18,30 €	054 / 19	24	33,80 €			
60				060 / 13	32	20,15 €	060 / 19	18	37,85 €	060 / 25	12	65,90 €
76				076 / 13	22	25,30 €	076 / 19	12	46,55 €	076 / 25	10	80,35 €
89				089 / 13	18	30,15 €	089 / 19	12	51,65 €	089 / 25	8	84,40 €

## PÁSY NH ARMAFLEX



Pásy zo syntetického kaučuku.

NH Armaflex			
Hr. izol. (mm)	Rola (šírka 1m) Obj. kód	m <sup>2</sup> / bal.	EUR/m <sup>2</sup> bez DPH
6	NH 06 -99 -E	15	46,95 €
9	NH 09 -99 -E	10	71,70 €
13	NH 13 -99 -E	8	84,15 €
19	NH 19 -99 -E	6	130,05 €
25	NH 25 -99 -E	4	160,25 €

Samolepiace pásy zo syntetického kaučuku

NH Armaflex (A) samolep			
Hr. izol. (mm)	Rola (šírka 1m) Obj. kód	m <sup>2</sup> / bal.	EUR/m <sup>2</sup> bez DPH
6	NH 06 -99 -EA	15	76,05 €
9	NH 09 -99 -EA	10	103,75 €
13	NH 13 -99 -EA	8	116,90 €
19	NH 19 -99 -EA	6	157,05 €
25	NH 25 -99 -EA	4	193,05 €

## TRUBICE ARMAFLEX ACe



Syntetický kaučuk (elastomer) čiernej farby, pre teploty od -50°C do +110°C. Vysoko ohybný izolačný materiál so štruktúrou uzavretých buniek, vysokým odporom proti difúzii vodnej pary a nízkou tepelnou vodivosťou.

Dĺžka trubice 2m. Faktor difúzneho odporu  $\mu > 7000$ . Súčiniteľ tepelnej vodivosti  $\lambda_{0^\circ\text{C}} = 0,036 \text{ W/m.K}$ .

Trieda reakcie na oheň D-s3, d0.

Vonk Ø potr (mm)	Armaflex ACe			Armaflex ACe			Armaflex ACe		
	Hr. izolácie 9 mm			Hr. izolácie 13 mm			Hr. izolácie 19 mm		
	Obj kód	bm/ bal.	EUR/bm bez DPH	Obj kód	bm/ bal.	EUR/bm bez DPH	Obj kód	bm/ bal.	EUR/bm bez DPH
18	018 / 9	166	1,60 €	018 / 13	104	2,45 €			
22	022 / 9	140	1,85 €	022 / 13	100	2,80 €	022 / 19	56	5,10 €
28	028 / 9	98	2,05 €	028 / 13	82	2,90 €	028 / 19	48	6,10 €
35	035 / 9	76	2,35 €	035 / 13	60	3,55 €	035 / 19	38	7,05 €
42	042 / 9	62	2,65 €	042 / 13	50	4,10 €	042 / 19	32	8,00 €
48				048 / 13	42	4,90 €	048 / 19	28	9,75 €
54				054 / 13	38	5,90 €	054 / 19	24	11,00 €
60				060 / 13	32	6,50 €	060 / 19	24	12,30 €
64				064 / 13	30	6,70 €	064 / 19	20	13,10 €
76				076 / 13	28	8,15 €	076 / 19	18	15,15 €
89				089 / 13	20	9,70 €	089 / 19	16	16,80 €
114				114 / 13	20	15,20 €	114 / 19	14	24,45 €

## PÁSY ARMAFLEX ACe

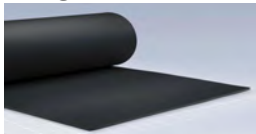

Izolačné pásy zo syntetického kaučuku.

Armaflex ACe			
Hr. izol. (mm)	Rola (šírka 1m) Obj.kód	m <sup>2</sup> / bal.	EUR/m <sup>2</sup> bez DPH
6	ACe 06 -99 -E	15	12,40 €
9	ACe 09 -99 -E	10	18,05 €
13	ACe 13 -99 -E	8	21,40 €
19	ACe 19 -99 -E	6	33,05 €
25	ACe 25 -99 -E	4	40,70 €
32	ACe 32 -99 -E	3	51,25 €
40	ACe 40 -99 -E	6	64,90 €
50	ACe 50 -99 -E	4	77,05 €

Samolepiace pásy zo syntetického kaučuku

Armaflex ACe (A) samolep			
Hr izol (mm)	Rola (šírka 1m) Obj.kód	m <sup>2</sup> / bal.	EUR/m <sup>2</sup> bez DPH
6	ACe 06 -99 -EA	15	19,35 €
9	ACe 09 -99 -EA	10	24,20 €
13	ACe 13 -99 -EA	8	28,40 €
19	ACe 19 -99 -EA	6	35,30 €
25	ACe 25 -99 -EA	4	57,25 €
32	ACe 32 -99 -EA	3	60,80 €
40	ACe 40 -99 -EA	6	75,30 €
50	ACe 50 -99 -EA	4	89,35 €

## TRUBICE ARMAFLEX ACe Plus

Syntetický kaučuk (elastomer) čiernej farby, pre teploty od -50°C do +110°C.

Dĺžka trubice 2m. Faktor difúzneho odporu  $\mu > 7000$ . Súčiniteľ tepelnej vodivosti  $\lambda_{0^\circ\text{C}} = 0,035 \text{ W/m.K}$ . Trieda reakcie na oheň B-s3, d0.

Vonk. Ø potr. (mm)	Armaflex Ace PLUS			Armaflex Ace PLUS			Armaflex Ace PLUS			Armaflex Ace PLUS		
	Hr. izolácie 6mm			Hr. izolácie 9 mm			Hr. izolácie 13 mm			Hr. izolácie 19 mm		
	Obj. kód	bm/ bal.	EUR/bm bez DPH	Obj. kód	bm/ bal.	EUR/bm bez DPH	Obj. kód	bm/ bal.	EUR/bm bez DPH	Obj. kód	bm/ bal.	EUR/bm bez DPH
6	006 / 6	568	1,15 €	006 / 9	362	1,30 €						
10	010 / 6	380	1,25 €	010 / 9	266	1,40 €	010 / 13	172	2,00 €			
12	012 / 6	330	1,25 €	012 / 9	234	1,50 €	012 / 13	162	2,10 €			
15	015 / 6	280	1,40 €	015 / 9	200	1,55 €	015 / 13	122	2,35 €	015 / 19	72	4,35 €
18	018 / 6	228	1,55 €							018 / 19	60	4,50 €
22	022 / 6	170	1,60 €									
28	028 / 6	128	1,80 €									
35	035 / 6	110	2,05 €									
48				048 / 9	54	3,10 €						
54				054 / 9	52	3,60 €						
60				060 / 9	48	4,50 €						
64				064 / 9	44	5,00 €						
76				076 / 9	32	6,00 €						
89				089 / 9	28	7,25 €						
108				108 / 9	26	10,95 €	108 / 13	20	13,85 €	108 / 19	16	23,20 €
114				114 / 9	24	11,80 €						
133							133 / 13	16	19,60 €	133 / 19	10	28,25 €
140										140 / 19	10	29,90 €
160							160 / 13	12	23,55 €	160 / 19	10	34,30 €

Vonk. Ø potr. (mm)	Armaflex Ace PLUS			Armaflex Ace PLUS			Armaflex Ace PLUS		
	Hr. izolácie 25 mm			Hr. izolácie 32 mm			Hr. izolácie 40mm		
	Obj. kód	bm/ bal.	EUR / bm bez DPH	Obj. kód	bm/ bal.	EUR / bm bez DPH	Obj. kód	bm/ bal.	EUR / bm bez DPH
22	022 / 25	40	7,00 €						
28	028 / 25	36	8,15 €	028 / 32	24	12,35 €			
35	035 / 25	24	8,95 €	035 / 32	18	14,80 €			
42	042 / 25	24	11,25 €	042 / 32	18	17,90 €	042 / 40	12	55,15 €
48	048 / 25	20	13,10 €	048 / 32	18	19,40 €	048 / 40	12	56,95 €
54	054 / 25	18	14,80 €	054 / 32	12	22,40 €	054 / 40	10	58,95 €
60	060 / 25	18	16,10 €	060 / 32	10	24,15 €	060 / 40	10	60,75 €
64	064 / 25	16	17,00 €	064 / 32	10	25,35 €	064 / 40	10	63,35 €
76	076 / 25	16	19,05 €	076 / 32	10	28,80 €	076 / 40	8	65,95 €
89	089 / 25	12	21,10 €	089 / 32	10	31,90 €	089 / 40	6	69,45 €
108	108 / 25	8	29,20 €				108 / 40	4	70,80 €
114	114 / 25	10	30,75 €	114 / 32	8	46,60 €	114 / 40	4	71,95 €
140	140 / 25	4	41,35 €	140 / 32	4	57,80 €	140 / 40	2	79,45 €
160				160 / 32	4	67,40 €			
168							168 / 40	4	90,15 €

## PÁSY ARMAFLEX DUCT



Plošná izolácia typu Armaflex ACe s hliníkovou fóliou vystuženou sklotextilnou mriežkou (ALS). Pásky sú vhodné k izolovaniu vzduchotechnických zariadení a potrubí v interiéri. Súčiniteľ tepelnej vodivosti  $\lambda_{0^{\circ}\text{C}} = 0,036 \text{ W/m.K}$ . Trieda reakcie na oheň E.

Samolepiace pásky zo syntetického kaučuku s povrchom ALS.

<b>Armaflex DUCT (A) samolep</b>			
<i>Hr. izol. (mm)</i>	<i>Rola (šírka 1m) Obj. kód</i>	<i>m<sup>2</sup>/ bal.</i>	<i>EUR/m<sup>2</sup> bez DPH</i>
<b>9</b>	DUCT AL 09 -EA	20	<b>15,90 €</b>
<b>13</b>	DUCT AL 13 -EA	16	<b>16,90 €</b>
<b>19</b>	DUCT AL 19 -EA	12	<b>23,60 €</b>
<b>25</b>	DUCT AL 25 -EA	8	<b>30,00 €</b>
<b>32</b>	DUCT AL 32 -EA	6	<b>38,80 €</b>

## TRUBICE Arma-Chek SILVER

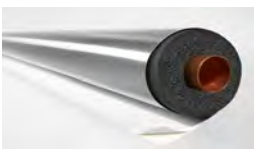

Trvalý a estetický systém ochrany izolácií. Izolačné trubice Armaflex s povrchom ARMA-CHEK SILVER (s lesklou pokovenou povrchovou úpravou). Povrch nahrádza oplechovanie, je odolný voči UV žiareniu, poveternostným vplyvom, vyznačuje sa vysokou pevnosťou a odolnosťou voči mechanickému poškodeniu. Teplotná odolnosť od -50°C do +110°C.

Dĺžka trubice 1m. Faktor difúzneho odporu  $\mu > 15\ 000$ . Súčiniteľ tep. vodivosti  $\lambda 0\ ^\circ\text{C} = 0,036\ \text{W/m.K}$ . Trieda reakcie na oheň E.

Vonk. Ø potr. (mm)	Arma-Chek SILVER			Arma-Chek SILVER			Arma-Chek SILVER			Arma-Chek SILVER		
	Hr. izolácie 13 mm			Hr. izolácie 19 mm			Hr. Izolácie 25 mm			Hr. izolácie 32 mm		
	Obj. kód	bm / bal.	EUR /bm bez DPH	Obj. kód	bm / bal.	EUR /bm bez DPH	Obj. kód	bm / bal.	EUR /bm bez DPH	Obj. kód	bm / bal.	EUR /bm bez DPH
15	015 / 13	61	27,95 €	015 / 19	39	32,00 €						
18	018 / 13	52	28,40 €	018 / 19	36	32,75 €						
22	022 / 13	50	29,20 €	022 / 19	32	33,80 €	022 / 25	20	41,00 €	022 / 32	12	47,05 €
28	028 / 13	41	30,95 €	028 / 19	24	37,35 €	028 / 25	18	43,00 €	028 / 32	12	51,55 €
35	035 / 13	30	33,90 €	035 / 19	18	38,75 €	035 / 25	12	45,45 €	035 / 32	9	53,05 €
42	042 / 13	25	35,85 €	042 / 19	16	41,30 €	042 / 25	11	47,00 €	042 / 32	8	58,05 €
48	048 / 13	21	38,80 €	048 / 19	14	44,30 €	048 / 25	9	52,90 €	048 / 32	6	65,25 €
54	054 / 13	19	39,95 €	054 / 19	12	46,10 €	054 / 25	9	60,90 €	054 / 32	6	68,60 €
60	060 / 13	16	41,20 €	060 / 19	12	47,80 €	060 / 25	9	64,40 €	060 / 32	5	74,60 €
64	064 / 13	15	45,05 €	064 / 19	10	51,85 €	064 / 25	6	70,00 €	064 / 32	5	85,95 €
76	076 / 13	14	49,80 €	076 / 19	9	55,45 €	076 / 25	6	72,65 €	076 / 32	5	94,60 €
89	089 / 13	9	52,90 €	089 / 19	8	59,60 €	089 / 25	5	79,05 €	089 / 32	5	101,05 €
114	114 / 13	9	67,95 €	114 / 19	7	74,90 €	114 / 25	3	93,25 €	114 / 32	2	128,85 €
125	125 / 13	9	99,35 €	125 / 19	5	112,65 €						
133	133 / 13	8	101,30 €	133 / 19	5	115,30 €	133 / 25	2	144,15 €			
140	140 / 13	6	103,55 €	140 / 19	5	117,55 €	140 / 25	2	146,45 €	140 / 32	2	177,75 €
160	160 / 13	6	128,00 €	160 / 19	5	143,45 €				160 / 32	1	186,30 €

## PÁSY Arma-Chek SILVER



Pásky zo syntetického kaučuku

Arma-Chek SILVER			
Hr. izol. (mm)	Roľa (šírka 1m) Obj. kód	m <sup>2</sup> / bal.	EUR/m <sup>2</sup> bez DPH
13	SI 13 -99 -E	8	37,85 €
19	SI 19 -99 -E	6	42,90 €
25	SI 25 -99 -E	4	48,20 €
32	SI 32 -99 -E	3	71,90 €
40	SI 40 -99 -E	7	131,10 €
50	SI 50 -99 -E	5	161,05 €

Samolepiace pásky zo syntetického kaučuku

Arma-Chek SILVER (A) samolep			
Hr. izol. (mm)	Roľa (šírka 1m) Obj. kód	m <sup>2</sup> / bal.	EUR/m <sup>2</sup> bez DPH
13	SI 13 -99 -EA	8	42,50 €
19	SI 19 -99 -EA	6	48,75 €
25	SI 25 -99 -EA	4	54,80 €
32	SI 32 -99 -EA	3	79,90 €
40	SI 40 -99 -EA	7	140,95 €
50	SI 50 -99 -EA	5	170,70 €

## TRUBICE HT ARMAFLEX

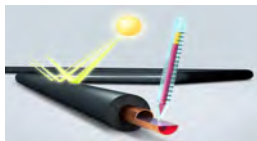

Ohybný izolačný elastomerový materiál na báze EPDM. Izolácia čiernej farby s mimoriadnou odolnosťou proti UV žiareniu a vysokým teplotám. Izolácia sa používa prevažne na izolovanie rozvodov solárnych aplikácií vo vonkajšom prostredí. Rozsah použitia od -50°C do +175°C (stála prevádzková teplota do +150°C). Lepiť len lepidlom HT 625. Dĺžka trubice 2m. Faktor dif. odporu  $\mu > 4000$ , súčiniteľ tepelnej vodivosti  $\lambda_{0^\circ\text{C}} = 0,040 \text{ W/m.K}$ . Trieda reakcie na oheň D-s3, d0.

Vonk. $\varnothing$ potr. (mm)	HT Armaflex			HT Armaflex			HT Armaflex			HT Armaflex		
	Hr. izolácie 10mm			Hr. izolácie 13 mm			Hr. izolácie 19 mm			Hr. izolácie 25 mm		
	Obj. kód	bm/ bal.	EUR/bm bez DPH	Obj. kód	bm/ bal.	EUR/bm bez DPH	Obj. kód	bm/ bal.	EUR/bm bez DPH	Obj. kód	bm/ bal.	EUR/bm bez DPH
10	010 / 10	192	4,50 €	010 / 13	140	6,10 €						
12	012 / 10	172	4,80 €	012 / 13	130	6,55 €	012 / 19	80	13,00 €			
15	015 / 10	144	4,90 €	015 / 13	112	7,35 €	015 / 19	64	13,35 €	015 / 25	40	20,70 €
18	018 / 10	130	5,35 €	018 / 13	98	7,95 €	018 / 19	58	13,80 €	018 / 25	36	21,00 €
22	022 / 10	108	5,90 €	022 / 13	84	8,65 €	022 / 19	50	15,80 €	022 / 25	36	22,70 €
28	028 / 10	82	6,70 €	028 / 13	64	9,35 €	028 / 19	48	18,95 €	028 / 25	32	28,35 €
35	035 / 10	60	7,45 €	035 / 13	50	11,45 €	035 / 19	32	21,70 €	035 / 25	24	29,90 €
42	042 / 10	50	8,45 €	042 / 13	40	12,70 €	042 / 19	24	24,55 €	042 / 25	20	36,15 €
48				048 / 13	32	15,25 €	048 / 19	22	29,90 €	048 / 25	16	40,60 €
54				054 / 13	32	18,15 €	054 / 19	18	33,80 €	054 / 25	16	46,25 €
60				060 / 13	28	20,15 €	060 / 19	16	38,20 €	060 / 25	16	50,45 €
76				076 / 13	24	25,35 €	076 / 19	18	46,50 €	076 / 25	12	61,40 €
89				089 / 13	18	30,15 €	089 / 19	16	51,60 €	089 / 25	12	67,65 €

## NEKONEČNÉ TRUBICE HT ARMAFLEX



Vonk. $\varnothing$ potr. (mm)	HT Armaflex			HT Armaflex		
	Hr. izolácie 13 mm			Hr. izolácie 19 mm		
	Obj. kód	bm/ bal.	EUR / bm bez DPH	Obj. kód	bm/ bal.	EUR / bm bez DPH
15	015 / 13 -E	26	7,35 €	015 / 19 -E	16	13,35 €
18	018 / 13 -E	22	7,95 €	018 / 19 -E	14	13,80 €
22	022 / 13 -E	18	8,65 €	022 / 19 -E	12	15,80 €

## PÁSY HT ARMAFLEX

Izolačné pásy zo syntetického kaučuku.

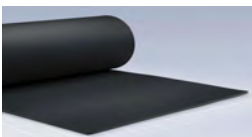

HT Armaflex			
Hr. izol. (mm)	Rola (šírka 1m) Obj. kód	m <sup>2</sup> / bal.	EUR/m <sup>2</sup> bez DPH
10	HT 10 -99 -E	10	69,90 €
13	HT 13 -99 -E	8	82,85 €
19	HT 19 -99 -E	6	128,00 €
25	HT 25 -99 -E	4	172,80 €



## TRUBICE HT ARMAFLEX S (SWH/SBK)



Materiál na báze penového syntetického elastomeru typu EPDM s pevnou UV odolnou bielou (SWH) alebo čiernou (SBK) PE povrchovou úpravou.

Rozsah použitia od -50°C do +175°C (stála prevádzková teplota do +150°C). Lepiť len lepidlom HT 625. Dĺžka trubice 2m.

Vonk. Ø potr. (mm)	HT Armaflex SWH			HT Armaflex SWH			HT Armaflex SWH		
	Hr. izolácie 13 mm			Hr. izolácie 20 mm			Hr. izolácie 32 mm		
	Obj. kód	bm / bal.	EUR /bm bez DPH	Obj. kód	bm / bal.	EUR /bm bez DPH	Obj. kód	bm / bal.	EUR /bm bez DPH
12	012 / 13 -SWH	130	11,45 €	012 / 20 -SWH	70	19,70 €			
15	015 / 13 -SWH	112	12,90 €	015 / 20 -SWH	64	23,75 €	015 / 32 -SWH	36	39,35 €
18	018 / 13 -SWH	98	14,00 €	018 / 20 -SWH	58	24,45 €	018 / 32 -SWH	30	40,00 €
22	022 / 13 -SWH	84	15,20 €	022 / 20 -SWH	50	27,95 €	022 / 32 -SWH	28	43,45 €
28	028 / 13 -SWH	64	16,45 €	028 / 20 -SWH	40	33,40 €	028 / 32 -SWH	24	49,85 €
35				035 / 20 -SWH	32	38,65 €	035 / 32 -SWH	22	56,10 €
42				042 / 20 -SWH	24	43,60 €	042 / 32 -SWH	18	61,55 €

Vonk. Ø potr. (mm)	HT Armaflex SBK			HT Armaflex SBK			HT Armaflex SBK		
	Hr. izolácie 13 mm			Hr. izolácie 20 mm			Hr. izolácie 32 mm		
	Obj. kód	bm / bal.	EUR /bm bez DPH	Obj. kód	bm / bal.	EUR /bm bez DPH	Obj. kód	bm / bal.	EUR /bm bez DPH
15				015 / 20 -SBK	64	23,75 €			
18	018 / 13 -SBK	98	12,90 €	018 / 20 -SBK	58	24,45 €	018 / 32 -SBK	30	40,00 €
22	022 / 13 -SBK	84	14,00 €	022 / 20 -SBK	50	27,95 €	022 / 32 -SBK	28	43,45 €
28	028 / 13 -SBK	64	15,20 €	028 / 20 -SBK	40	33,40 €	028 / 32 -SBK	24	49,85 €
35				035 / 20 -SBK	32	38,65 €	035 / 32 -SBK	22	56,10 €
42				042 / 20 -SBK	24	43,60 €	042 / 32 -SBK	18	61,55 €

## ZÁVESY RF s kovovou objímkou



Izolačné závesy pre chladiacu a klimatizačnú techniku.  
Kovovú objímkou do priemeru 108mm má vnútorný závit M8/M10.  
Izolačný záves slúži ku kompletnému odizolovaniu chladového systému.

Vonk. Ø potr. (mm)	RF s kov. objímkou					RF s kov. objímkou				
	Hr. izolácie 13 mm					Hr. izolácie 19 mm				
	Vzdialeno st'	Vonkajší Ø	Obj. kód	ks/ bal.	EUR/ks bez DPH	Vzdialeno st'	Vonkajší Ø	Obj. kód	ks/ bal.	EUR/ks bez DPH
22	2,75	48	022 / 13	20	3,15 €	2,75	60	022 / 19	20	4,85 €
28	3	54	028 / 13	20	3,45 €	3	66	028 / 19	20	5,45 €
35	3,5	61	035 / 13	20	3,55 €	3,5	73	035 / 19	20	5,55 €
42	3,75	68	042 / 13	20	4,35 €	3,75	80	042 / 19	20	6,20 €
48	4,25	74	048 / 13	20	4,55 €	4,25	86	048 / 19	20	6,35 €
54	4,25	80	054 / 13	20	4,80 €	4,25	92	054 / 19	20	6,65 €
60	4,75	86	060 / 13	20	5,25 €	4,75	98	060 / 19	20	7,15 €
64	4,75	90	064 / 13	20	5,60 €	4,75	102	064 / 19	20	7,40 €
76	5,5	102	076 / 13	20	6,35 €	5,5	114	076 / 19	20	8,15 €
89	6	115	089 / 13	20	7,25 €	6	127	089 / 19	20	9,85 €
108	6	136	108 / 13	20	9,65 €	6	148	108 / 19	20	12,70 €

## Kovové objímky (dvojskrutkové) 2S M8/M10



Vhodné pre izolačné závesy:				Kov. objímka 2S M8/M10		
13 mm	19 mm	25 mm	32 mm	Obj. kód	ks/ bal.	EUR/ks bez DPH
9, 10, 12				Ø 31-37	50	0,55 €
15, 18				Ø 38-46	50	0,65 €
22	10, 12			Ø 47-52	50	0,65 €
28, 35	15, 18, 22			Ø 53-61	50	0,70 €
		15		Ø 62-67	50	0,80 €
42, 48	28, 35	18, 22		Ø 68-74	50	0,95 €
54	42	28	15	Ø 75-81	50	1,10 €
60	48	35	18, 22	Ø 82-87	50	1,15 €
64	54	42	28	Ø 88-95	50	1,40 €
76	60, 64	48	35	Ø 96-103	50	1,45 €
		54, 60	42, 48	Ø 104-112	25	1,60 €
89	76	64	54	Ø 113-118	25	1,80 €
	89	76	60	Ø 119-127	25	1,95 €

Vhodné pre izolačné závesy:				Kov. objímka 2S M8/M10		
13 mm	19 mm	25 mm	32 mm	Obj. kód	ks/ bal.	EUR/ks bez DPH
108			64	Ø 128-137	25	2,20 €
114		89	76	Ø 138-144	25	2,30 €
	108		89	Ø 145-153	25	2,50 €
133	114	108		Ø 154-162	25	2,55 €
140		114		Ø 163-172	25	2,90 €
	133, 140		108, 114	Ø 173-183	15	3,20 €
160		133, 140		Ø 184-194	15	3,20 €
168	160		133	Ø 195-205	15	3,40 €
	168	160	140	Ø 206-216	15	3,55 €
		168	160	Ø 217-225	15	4,35 €



Izolačné závesy pre chladiacu a klimatizačnú techniku. Chladová objímka (nosník trubiek) slúži ku kompletnému odizolovaniu chladového systému. Vysoká ochrana proti tepelným mostom.

Vonk. Ø potr. (mm)	Kaiflex RT ST					Kaiflex RT ST					Kaiflex RT ST					Kaiflex RT ST				
	Hr. izolácie 13 mm					Hr. izolácie 19 mm					Hr. izolácie 25 mm					Hr. izolácie 32 mm				
	Vzdialen ost'	Vonkajší Ø	Obj. kód	ks/bal.	EUR/ks bez DPH	Vzdialen ost'	Vonkajší Ø	Obj. kód	ks/bal.	EUR/ks bez DPH	Vzdialen ost'	Vonkajší Ø	Obj. kód	ks/bal.	EUR/ks bez DPH	Vzdialen ost'	Vonkajší Ø	Obj. kód	ks/bal.	EUR/ks bez DPH
10	2	36	010 / 13	52	2,35 €	2	48	010 / 19	32	2,85 €	2	60	010 / 25	32	3,25 €					
12	2	38	012 / 13	48	2,45 €	2	50	012 / 19	28	2,90 €	2	62	012 / 25	28	3,35 €					
15	2	41	015 / 13	40	2,55 €	2	53	015 / 19	22	3,00 €	2	65	015 / 25	24	3,45 €	2	79	015 / 32	18	3,65 €
18	2,25	44	018 / 13	32	2,60 €	2,25	56	018 / 19	20	3,10 €	2,25	68	018 / 25	24	3,55 €	2,25	82	018 / 32	28	3,90 €
22	2,75	48	022 / 13	32	2,95 €	2,75	60	022 / 19	32	3,20 €	2,75	72	022 / 25	38	3,90 €	2,75	86	022 / 32	24	4,20 €
28	3	54	028 / 13	40	3,30 €	3	66	028 / 19	24	3,75 €	3	78	028 / 25	32	4,50 €	3	92	028 / 32	24	4,80 €
35	3,5	61	035 / 13	30	3,55 €	3,5	73	035 / 19	38	4,10 €	3,5	85	035 / 25	26	5,00 €	3,5	99	035 / 32	18	5,50 €
42	3,75	68	042 / 13	46	3,60 €	3,75	80	042 / 19	32	4,35 €	3,75	92	042 / 25	22	5,40 €	3,75	106	042 / 32	40	5,95 €
48	4,25	74	048 / 13	34	3,80 €	4,25	86	048 / 19	28	4,45 €	4,25	98	048 / 25	40	5,60 €	4,25	112	048 / 32	30	6,25 €
54	4,25	80	054 / 13	32	3,95 €	4,25	92	054 / 19	48	4,60 €	4,25	104	054 / 25	40	6,15 €	4,25	118	054 / 32	30	6,70 €
57	4,25	83	057 / 13		4,15 €	4,25	95	057 / 19		4,80 €										
60	4,75	86	060 / 13	56	4,35 €	4,75	98	060 / 19	44	5,05 €	4,75	110	060 / 25	36	7,15 €	4,75	124	060 / 32	26	8,05 €
64	4,75	90	064 / 13	48	4,80 €	5	102	064 / 19	40	5,65 €	5	114	064 / 25	30	7,20 €	5	128	064 / 32	24	8,50 €
70	4,75	96	070 / 13	44	5,30 €	5	108	070 / 19	32	6,20 €						5	134	070 / 32	22	9,00 €
76	5,5	102	076 / 13	40	6,05 €	5,5	114	076 / 19	30	6,60 €	5,5	126	076 / 25	24	8,50 €	5,5	140	076 / 32	22	9,45 €
80	6	106	080 / 13	36	6,40 €	6	118	080 / 19	28	7,70 €										
89	6	115	089 / 13	30	6,45 €	6	127	089 / 19	26	7,80 €	6	139	089 / 25	22	10,00 €	6	153	089 / 32	16	11,20 €
108	6	136	108 / 13	22	7,50 €	6	148	108 / 19	18	9,10 €	6	160	108 / 25	16	10,90 €	6	174	108 / 32	12	13,40 €
114	6	142	114 / 13	18	8,65 €	6	154	114 / 19	16	9,60 €	6	166	114 / 25	12	15,85 €	6	180	114 / 32	12	14,60 €
125		153				6	165	125 / 19	12	11,60 €		177					191			
133	6	161	133 / 13	14	11,80 €	6	173	133 / 19	12	11,85 €		185				6	199	133 / 32	8	17,65 €
140	6	168	140 / 13	14	12,60 €	6	180	140 / 19	12	13,00 €	6	192	140 / 25	12	16,20 €	6	206	140 / 32	8	18,55 €
160	6	188	160 / 13	12	13,65 €	6	200	160 / 19	8	15,10 €	6	212	160 / 25	8	18,45 €	6	226	160 / 32	6	19,25 €
168	6	196	168 / 13	12	14,35 €	6	208	168 / 19	8	16,10 €	6	220	168 / 25	6	18,60 €	6	234	168 / 32	6	23,00 €
219	6	247	219 / 13	4	16,30 €	6	259	219 / 19	4	20,70 €	6	271	219 / 25	4	28,20 €	6	285	219 / 32	4	35,30 €

## TRUBICE KAIFLEX ST



Vysoko ohybný izolačný mat. so štruktúrou uzavretých buniek (Flexible Elastomeric Foam- FEF).  
Izolácia čiernej farby s vysokým odporom proti difúzii vodnej pary a nízkou tepelnou vodivosťou pre teploty od -50°C do +110°C. Dĺžka 2m. Faktor difúzneho odporu  $\mu > 10000$ . Súčiniteľ tep. vodivosti  $\lambda_{0^\circ\text{C}} = 0,034 \text{ W/m.K}$ . Trieda reakcie na oheň B-s2, d0.



Vonk. Ø potr. (mm)	Kaiflex ST			Kaiflex ST			Kaiflex ST			Kaiflex ST			Kaiflex ST		
	Hr. izolácie 9 mm			Hr. izolácie 13 mm			Hr. izolácie 19 mm			Hr. izolácie 25 mm			Hr. izolácie 32 mm		
	Obj. kód	bm/ bal.	EUR/bm bez DPH	Obj. kód	bm/ bal.	EUR/bm bez DPH	Obj. kód	bm/ bal.	EUR/bm bez DPH	Obj. kód	bm/ bal.	EUR/bm bez DPH	Obj. kód	bm/ bal.	EUR/bm bez DPH
6	006 / 9	360	1,10 €	006 / 13	240	1,45 €									
8	008 / 9	340	1,15 €	008 / 13	210	1,65 €									
10	010 / 9	320	1,20 €	010 / 13	190	1,75 €	010 / 19	106	2,95 €	010 / 25	72	5,25 €			
12	012 / 9	280	1,30 €	012 / 13	172	1,85 €	012 / 19	100	3,05 €	012 / 25	60	5,30 €	012 / 32	36	8,70 €
15	015 / 9	240	1,35 €	015 / 13	154	2,00 €	015 / 19	86	3,65 €	015 / 25	60	5,40 €	015 / 32	32	9,10 €
18	018 / 9	190	1,35 €	018 / 13	130	2,20 €	018 / 19	78	3,85 €	018 / 25	50	5,55 €	018 / 32	32	9,45 €
22	022 / 9	156	1,65 €	022 / 13	110	2,35 €	022 / 19	74	4,35 €	022 / 25	42	6,20 €	022 / 32	32	10,00 €
25	025 / 9	130	1,70 €	025 / 13	92	2,40 €									
28	028 / 9	124	1,75 €	028 / 13	86	2,50 €	028 / 19	58	5,20 €	028 / 25	40	6,55 €	028 / 32	24	10,50 €
35	035 / 9	92	1,95 €	035 / 13	76	3,05 €	035 / 19	48	5,95 €	035 / 25	32	7,15 €	035 / 32	24	10,65 €
42	042 / 9	70	2,20 €	042 / 13	56	3,40 €	042 / 19	40	6,70 €	042 / 25	24	8,95 €	042 / 32	24	12,85 €
45	045 / 9	60	2,50 €				045 / 19	34	8,20 €						
48	048 / 9	60	2,65 €	048 / 13	48	4,20 €	048 / 19	30	8,30 €	048 / 25	24	10,45 €	048 / 32	18	13,85 €
54	054 / 9	60	3,05 €	054 / 13	46	4,95 €	054 / 19	30	9,20 €	054 / 25	22	11,80 €	054 / 32	18	16,05 €
60	060 / 9	60	3,85 €	060 / 13	40	5,45 €	060 / 19	28	10,25 €	060 / 25	22	12,75 €	060 / 32	16	17,30 €
64	064 / 9	54	4,20 €	064 / 13	40	5,60 €	064 / 19	28	11,00 €	064 / 25	18	13,65 €	064 / 32	16	18,10 €
70	070 / 9	54	4,60 €	070 / 13	40	6,30 €	070 / 19	28	11,70 €	070 / 25	18	15,60 €	070 / 32	14	19,60 €
76	076 / 9	54	5,05 €	076 / 13	34	6,85 €	076 / 19	28	12,65 €	076 / 25	18	15,30 €	076 / 32	12	20,65 €
80	080 / 9	40	5,85 €	080 / 13	30	7,50 €	080 / 19	26	13,65 €				080 / 32	12	21,90 €
89	089 / 9	36	6,15 €	089 / 13	30	8,10 €	089 / 19	22	14,05 €	089 / 25	14	16,85 €	089 / 32	10	22,80 €
108	108 / 9	28	9,60 €	108 / 13	28	11,55 €	108 / 19	20	19,40 €	108 / 25	10	23,10 €	108 / 32	8	31,55 €
114	114 / 9	28	10,25 €	114 / 13	28	12,70 €	114 / 19	18	20,45 €	114 / 25	10	24,50 €	114 / 32	8	33,30 €
125	125 / 9	20	11,95 €	125 / 13	20	16,50 €	125 / 19	18	22,65 €						
133	133 / 9	16	14,15 €	133 / 13	18	17,20 €	133 / 19	12	23,65 €				133 / 32	6	39,15 €
140	140 / 9	16	14,70 €	140 / 13	18	17,70 €	140 / 19	10	25,10 €	140 / 25	6	32,65 €	140 / 32	6	41,35 €
160				160 / 13	16	20,55 €	160 / 19	8	28,70 €				160 / 32	4	48,20 €
168							168 / 19	8	29,95 €				168 / 32	4	61,65 €

## TRUBICE KAIFLEX ST



Vonk. Ø potr. (mm)	Kaiflex ST			Kaiflex ST		
	Hr. izolácie 40 mm			Hr. izolácie 50 mm		
	Obj. kód	bm/ bal.	EUR/bm bez DPH	Obj. kód	bm/ bal.	EUR/bm bez DPH
18	018 / 40	22	24,35 €	018 / 50	14	45,10 €
22	022 / 40	22	25,50 €	022 / 50	14	48,20 €
28	028 / 40	16	27,80 €	028 / 50	10	50,15 €
35	035 / 40	16	29,95 €	035 / 50	8	53,40 €
42	042 / 40	16	32,10 €	042 / 50	8	58,10 €
48	048 / 40	12	35,90 €	048 / 50	8	58,70 €
54	054 / 40	10	38,00 €	054 / 50	8	62,00 €
60	060 / 40	10	39,00 €	060 / 50	8	62,15 €
64	064 / 40	10	40,30 €	064 / 50	6	66,05 €
76	076 / 40	10	46,15 €	076 / 50	6	66,65 €
89	089 / 40	10	48,70 €	089 / 50	6	72,35 €
114	114 / 40	6	52,45 €	114 / 50	4	98,90 €
140	140 / 40	6	57,75 €	140 / 50	2	116,00 €
160	160 / 40	4	80,15 €	160 / 50	2	139,60 €
168	168 / 40	4	92,10 €	168 / 50		

## PÁSY KAIFLEX ST



Izolačné pásy zo syntetického kaučuku.

Kaiflex ST			
Hr. izol. (mm)	Rola (šírka 1m) Obj. kód	m <sup>2</sup> / bal.	EUR/m <sup>2</sup> bez DPH
6	ST 06	30	10,25 €
10	ST 10	20 (10)	15,20 €
13	ST 13	14 (8)	17,75 €
16	ST 16	12	22,90 €
19	ST 19	10 (6)	27,35 €
25	ST 25	8 (4)	33,65 €
32	ST 32	6 (3)	42,35 €
40	ST 40	5,5	57,30 €
50	ST 50	4	77,10 €

Samolepiace pásy zo syntetického kaučuku.

Kaiflex ST (SA)			
Hr. izol. (mm)	Rola (šírka 1m) Obj. kód	m <sup>2</sup> / bal.	EUR/m <sup>2</sup> bez DPH
6	ST 06 -SA	30	18,45 €
10	ST 10 -SA	20 (10)	23,00 €
13	ST 13 -SA	14 (8)	27,65 €
16	ST 16 -SA	12	30,60 €
19	ST 19 -SA	10 (6)	35,60 €
25	ST 25 -SA	8 (4)	42,00 €
32	ST 32 -SA	6 (3)	50,90 €
40	ST 40 -SA	5,5	65,90 €
50	ST 50 -SA	4	85,70 €

# ENVIRONMENTAL PRODUCT DECLARATION

as per /ISO 14025/ and /EN 15804/

Owner of the Declaration	Kaimann GmbH
Programme holder	Institut Bauen und Umwelt e.V. (IBU)
Publisher	Institut Bauen und Umwelt e.V. (IBU)
Declaration number	EPD-KAI-20190093-IBC1-EN
Issue date	19.08.2019
Valid to	18.08.2024

**Kaiflex ST**  
**Kaimann GmbH**

[www.ibu-epd.com](http://www.ibu-epd.com) / <https://epd-online.com>

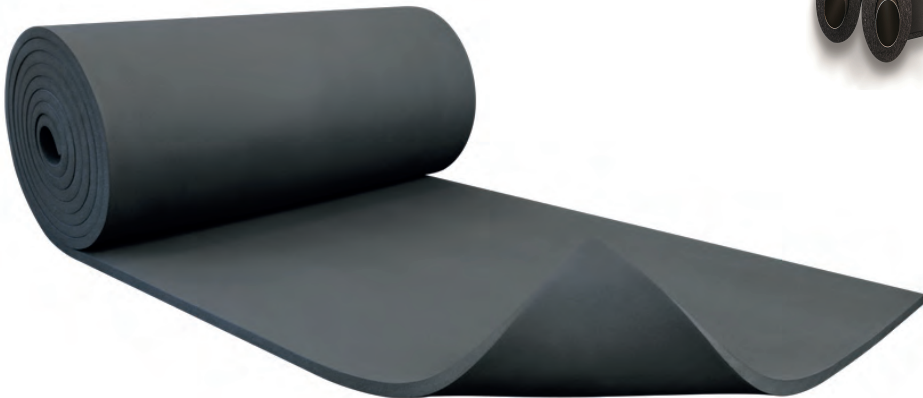

## TRUBICE KAIFLEX ST endless

"Nekonečné" hadice Kaiflex ST.



Vonk. Ø potr. (mm)	Kaiflex ST endless			Kaiflex ST endless			Kaiflex ST endless		
	Hr. izolácie 6 mm			Hr. izolácie 9 mm			Hr. izolácie 13 mm		
	Obj. kód	bm/ bal.	EUR/bm bez DPH	Obj. kód	bm/ bal.	EUR/bm bez DPH	Obj. kód	bm/ bal.	EUR/bm bez DPH
6	006 / 6 -E	50	1,00 €	006 / 9 -E	40	1,10 €	006 / 13 -E	26	1,45 €
8	008 / 6 -E	48	1,05 €	008 / 9 -E	37	1,15 €	008 / 13 -E	26	1,65 €
10	010 / 6 -E	46	1,05 €	010 / 9 -E	34	1,20 €	010 / 13 -E	23	1,75 €
12	012 / 6 -E	40	1,10 €	012 / 9 -E	31	1,30 €	012 / 13 -E	18	1,85 €
15	015 / 6 -E	38	1,20 €	015 / 9 -E	27	1,35 €	015 / 13 -E	17	2,00 €
18	018 / 6 -E	30	1,30 €	018 / 9 -E	23	1,35 €	018 / 13 -E	15	2,20 €
22	022 / 6 -E	23	1,35 €	022 / 9 -E	19	1,65 €	022 / 13 -E	14	2,35 €
28	028 / 6 -E	20	1,50 €	028 / 9 -E	14	1,75 €	028 / 13 -E	10	2,50 €

## TRUBICE KAIFLEX ST SA

Samolepiace trubice Kaiflex ST SA. Dĺžka trubice 2m.



Vonk. Ø potr. (mm)	Kaiflex (SA)			Kaiflex (SA)			Kaiflex (SA)		
	Hr. izolácie 9 mm			Hr. izolácie 13 mm			Hr. izolácie 19 mm		
	Obj. kód	bm/ bal.	EUR/ bm bez DPH	Obj. kód	bm/ bal.	EUR/ bm bez DPH	Obj. kód	bm/ bal.	EUR/ bm bez DPH
15	015 / 9 -SA	240	2,95 €	015 / 13 -SA	154	3,85 €	015 / 19 -SA	86	5,35 €
18	018 / 9 -SA	190	3,10 €	018 / 13 -SA	130	4,15 €	018 / 19 -SA	78	5,70 €
22	022 / 9 -SA	156	3,25 €	022 / 13 -SA	110	4,40 €	022 / 19 -SA	74	6,40 €
28	028 / 9 -SA	124	3,65 €	028 / 13 -SA	86	4,70 €	028 / 19 -SA	58	7,30 €
35	035 / 9 -SA	92	3,95 €	035 / 13 -SA	76	4,90 €	035 / 19 -SA	48	8,20 €
42	042 / 9 -SA	70	4,55 €	042 / 13 -SA	56	6,00 €	042 / 19 -SA	40	9,80 €
48	048 / 9 -SA	60	5,00 €	048 / 13 -SA	48	6,60 €	048 / 19 -SA	30	10,90 €
54	054 / 9 -SA	60	5,45 €	054 / 13 -SA	46	7,95 €	054 / 19 -SA	30	11,75 €
60	060 / 9 -SA	60	6,90 €	060 / 13 -SA	40	8,40 €	060 / 19 -SA	28	13,30 €
76	076 / 9 -SA	54	8,55 €	076 / 13 -SA	34	11,55 €	076 / 19 -SA	28	17,40 €
89	089 / 9 -SA	36	10,20 €	089 / 13 -SA	30	13,95 €	089 / 19 -SA	22	19,70 €

## TRUBICE KAIFLEX EF



Vysoko ohybný izolačný materiál so štruktúrou uzavretých buniek (Flexible Elastomeric Foam- FEF).  
 Izolácia čiernej farby pre teploty od -50°C do +110°C. Dĺžka trubice 2m. Faktor difúzneho odporu  $\mu > 8000$ .  
 Súčiniteľ tepelnej vodivosti  $\lambda_{0^\circ\text{C}} = 0,036 \text{ W/m.K}$ . Trieda reakcie na oheň B-s3,d0.



Vonk. Ø potr. (mm)	Kaiflex EF			Kaiflex EF			Kaiflex EF		
	Hr. izolácie 6 mm			Hr. izolácie 9 mm			Hr. izolácie 13 mm		
	Obj. kód	bm/ bal.	EUR/bm bez DPH	Obj. kód	bm/ bal.	EUR/bm bez DPH	Obj. kód	bm/ bal.	EUR/bm bez DPH
6	006 / 6	600	<del>0,76 €</del>	006 / 9	360	<del>0,90 €</del>	006 / 13	240	<del>1,30 €</del>
8	008 / 6	500	<del>0,82 €</del>	008 / 9	340	<del>0,96 €</del>	008 / 13	210	<del>1,35 €</del>
10	010 / 6	430	<del>0,90 €</del>	010 / 9	320	<del>1,04 €</del>	010 / 13	190	<del>1,50 €</del>
12	012 / 6	350	<del>0,96 €</del>	012 / 9	280	<del>1,10 €</del>	012 / 13	172	<del>1,55 €</del>
15	015 / 6	300	<del>1,04 €</del>	015 / 9	240	<del>1,14 €</del>	015 / 13	154	<del>1,75 €</del>
18	018 / 6	280	<del>1,10 €</del>	018 / 9	190	<del>1,22 €</del>	018 / 13	130	<del>1,80 €</del>
22	022 / 6	216	<del>1,14 €</del>	022 / 9	156	<del>1,34 €</del>	022 / 13	110	<del>2,05 €</del>
28	028 / 6	150	<del>1,28 €</del>	028 / 9	124	<del>1,60 €</del>	028 / 13	86	<del>2,25 €</del>
35	035 / 6	120	<del>1,68 €</del>	035 / 9	92	<del>1,78 €</del>	035 / 13	76	<del>2,70 €</del>
42				042 / 9	70	<del>2,06 €</del>	042 / 13	56	<del>3,15 €</del>
45				045 / 9	60	<del>2,24 €</del>			
48				048 / 9	60	<del>2,38 €</del>	048 / 13	48	<del>3,65 €</del>
54				054 / 9	60	<del>3,02 €</del>	054 / 13	46	<del>4,35 €</del>
60				060 / 9	60	<del>3,52 €</del>	060 / 13	40	<del>4,80 €</del>
64				064 / 9	54	<del>4,00 €</del>	064 / 13	40	<del>5,30 €</del>
70				070 / 9	54	<del>4,48 €</del>	070 / 13	40	<del>5,60 €</del>
76				076 / 9	54	<del>4,66 €</del>	076 / 13	34	<del>6,00 €</del>
80				080 / 9	40	<del>5,36 €</del>	080 / 13	30	<del>7,10 €</del>
89				089 / 9	36	<del>5,60 €</del>	089 / 13	30	<del>7,25 €</del>
102				102 / 9	28	<del>7,60 €</del>	102 / 13	30	<del>9,70 €</del>
108				108 / 9	28	<del>9,40 €</del>	108 / 13	28	<del>10,20 €</del>
114				114 / 9	28	<del>9,70 €</del>	114 / 13	28	<del>11,30 €</del>
125				125 / 9	20	<del>11,40 €</del>	125 / 13	20	<del>16,60 €</del>
133				133 / 9	16	<del>13,70 €</del>	133 / 13	18	<del>17,10 €</del>
140				140 / 9	16	<del>14,70 €</del>	140 / 13	18	<del>17,50 €</del>
160				160 / 9	14	<del>16,10 €</del>	160 / 13	16	<del>19,00 €</del>



Vonk. Ø potr. (mm)	Kaiflex EF			Kaiflex EF			Kaiflex EF		
	Hr. izolácie 19 mm			Hr. izolácie 25 mm			Hr. izolácie 32 mm		
	Obj. kód	bm/ bal.	EUR/bm bez DPH	Obj. kód	bm/ bal.	EUR/bm bez DPH	Obj. kód	bm/ bal.	EUR/bm bez DPH
10	010 / 19	106	2,65 €	010 / 25	72	3,75 €			
12	012 / 19	100	2,70 €	012 / 25	60	3,85 €			
15	015 / 19	86	3,20 €	015 / 25	60	4,60 €	015 / 32	32	6,90 €
18	018 / 19	78	3,60 €	018 / 25	50	5,10 €	018 / 32	32	7,00 €
22	022 / 19	74	3,95 €	022 / 25	42	5,20 €	022 / 32	32	7,40 €
28	028 / 19	58	4,60 €	028 / 25	40	6,00 €	028 / 32	24	8,20 €
35	035 / 19	48	5,60 €	035 / 25	32	6,60 €	035 / 32	24	9,80 €
42	042 / 19	40	6,65 €	042 / 25	24	8,25 €	042 / 32	22	11,80 €
45	045 / 19	34	7,40 €						
48	048 / 19	30	7,50 €	048 / 25	24	9,60 €	048 / 32	18	12,70 €
54	054 / 19	30	8,50 €	054 / 25	22	10,85 €	054 / 32	18	14,70 €
60	060 / 19	28	9,25 €	060 / 25	22	11,75 €	060 / 32	16	15,80 €
64	064 / 19	28	10,10 €	064 / 25	18	12,60 €	064 / 32	16	16,60 €
70	070 / 19	28	11,10 €	070 / 25	18	14,35 €	070 / 32	14	18,00 €
76	076 / 19	28	12,10 €	076 / 25	18	14,65 €	076 / 32	12	18,90 €
80	080 / 19	26	13,00 €				080 / 32	12	20,10 €
89	089 / 19	22	13,05 €	089 / 25	14	15,85 €	089 / 32	10	21,00 €
108	108 / 19	20	18,50 €	108 / 25	10	21,70 €	108 / 32	8	29,70 €
114	114 / 19	18	19,00 €	114 / 25	10	23,00 €	114 / 32	8	31,40 €
125	125 / 19	18	21,40 €						
133	133 / 19	12	23,00 €	133 / 25	8	28,90 €	133 / 32	6	36,90 €
140	140 / 19	10	24,60 €	140 / 25	6	30,70 €	140 / 32	6	38,90 €
160	160 / 19	8	26,70 €				160 / 32	4	45,40 €

PÁSY KAIFLEX EF



Izolačné pásy zo syntetického kaučuku.

Kaiflex EF			
Hr. izol. (mm)	Rola (šírka 1m) Obj. kód	m <sup>2</sup> /bal.	EUR/m <sup>2</sup> bez DPH
6	EF 06	(18)	9,70 €
10	EF 10	(10)	14,35 €
13	EF 13	(8)	16,65 €
19	EF 19	(6)	25,75 €
25	EF 25	(4)	31,70 €
32	EF 32	(3)	39,85 €
16	EF 16	12 (7)	21,50 €
40	EF 40	5,5	55,90 €
50	EF 50	4	72,50 €

Samolepiace pásy zo syntetického kaučuku.

Kaiflex EF (SA)			
Hr. izol. (mm)	Rola (šírka 1m) Obj. kód	m <sup>2</sup> /bal.	EUR/m <sup>2</sup> bez DPH
6	EF 06 -SA	(18)	17,40 €
10	EF 10 -SA	(10)	21,65 €
13	EF 13 -SA	(8)	26,05 €
19	EF 19 -SA	(6)	33,50 €
25	EF 25 -SA	(4)	40,05 €
32	EF 32 -SA	(3)	48,20 €
16	EF 16 -SA	12 (7)	28,80 €
40	EF 40 -SA	5,5	64,30 €
50	EF 50 -SA	4	80,90 €

## PÁSY KAIFLEX DUCT

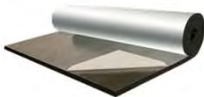

Pásy určené prevažne k izolovaniu potrubí a VZT zariadení.

Faktor difúzneho odporu  $\mu > 5000$ . Súčiniteľ tepelnej vodivosti  $\lambda 0^{\circ}\text{C} = 0,036 \text{ W/m.K}$ . Trieda reakcie na oheň E.



Samolepiace izolačné pásy.Šírka 1m.

<b>Kaiflex DUCT (SA)</b>			
Hr. izol. (mm)	Rola (šírka 1m) Obj. kód	m <sup>2</sup> / bal.	EUR/m <sup>2</sup> bez DPH
6	Duct 06 -SA	18	8,80 €
8	Duct 08 -SA	14	9,70 €
10	Duct 10 -SA	10	11,00 €
12	Duct 12 -SA	8	13,00 €
15	Duct 15 -SA	7	15,50 €
20	Duct 20 -SA	6	17,60 €
25	Duct 25 -SA	4	22,10 €
30	Duct 30 -SA	3	24,00 €

Samolepiace izolačné pásy s kovovo lesklým povrchom.Šírka 1m.

<b>Kaiflex DUCT ALU (SA)</b>			
Hr. izol. (mm)	Rola (šírka 1m) Obj. kód	m <sup>2</sup> / bal.	EUR/m <sup>2</sup> bez DPH
6	Duct ALU 06 -SA	18	11,90 €
8	Duct ALU 08 -SA	14	12,80 €
10	Duct ALU 10 -SA	10	14,10 €
12	Duct ALU 12 -SA	8	16,00 €
15	Duct ALU 15 -SA	7	19,40 €
20	Duct ALU 20 -SA	6	20,60 €
25	Duct ALU 25 -SA	4	28,90 €
30	Duct ALU 30 -SA	3	31,90 €

## TRUBICE KAIFLEX ST PROTECT ALU-TEC

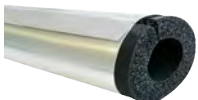

Izolácia s kovovo lesklou vysoko odolnou povrchovou úpravou. Dobrá UV odolnosť a vynikajúca mechanická ochrana. Vhodné ako náhrada oplechovania potrubných rozvodov a zariadení s teplotou od -30°C do +80°C. Dĺžka trubice 1m. Faktor difúzneho odporu  $\mu > 10000$ . Súčiniteľ tepelnej vodivosti  $\lambda 0^\circ\text{C} = 0,034 \text{ W/m.K}$ . Trieda reakcie na oheň E.



Vonk. Ø potr. (mm)	Protect ALU-TEC			Protect ALU-TEC			Protect ALU-TEC		
	Hr. izolácie 13 mm			Hr. izolácie 19 mm			Hr. izolácie 25 mm		
	Obj. kód	bm/ bal.	EUR/bm bez DPH	Obj. kód	bm/ bal.	EUR/bm bez DPH	Obj. kód	bm/ bal.	EUR/bm bez DPH
15	015 / 13	77	18,20 €	015 / 19	43	23,45 €			
18	018 / 13	65	18,60 €	018 / 19	39	24,05 €	018 / 25	25	28,85 €
22	022 / 13	55	19,15 €	022 / 19	37	24,80 €	022 / 25	21	31,75 €
28	028 / 13	43	20,65 €	028 / 19	29	26,75 €	028 / 25	20	33,75 €
35	035 / 13	38	22,20 €	035 / 19	24	29,30 €	035 / 25	16	35,85 €
42	042 / 13	28	24,30 €	042 / 19	17	31,30 €	042 / 25	12	39,15 €
48	048 / 13	24	25,80 €	048 / 19	15	34,35 €	048 / 25	12	
54	054 / 13	23	28,95 €	054 / 19	14	39,60 €	054 / 25	11	44,75 €
60	060 / 13	20	32,10 €	060 / 19	14	41,80 €	060 / 25	11	51,00 €
64	064 / 13	20	33,25 €	064 / 19	14	43,45 €	064 / 25	9	53,70 €
76	076 / 13	17	36,80 €	076 / 19	14	46,80 €	076 / 25	9	58,00 €
89	089 / 13	15	39,60 €	089 / 19	11	51,95 €	089 / 25	7	63,50 €
114	114 / 13	14	47,60 €	114 / 19	9	62,60 €	114 / 25	5	76,35 €
160				160 / 19	4	87,75 €			

Rozmery izolácie od Ø 15 do Ø89 sú s rozrezanou izoláciou v samolepiacom prevedení, rozmery od Ø108 do Ø160 sú len s rozrezanou izoláciou.

## PÁSY KAIFLEX PROTECT ALU-TEC

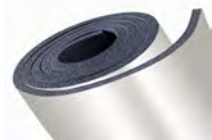

Izolačné pásy s povrchom PROTECT ALU-TEC.

Kaiflex Protect ALU-TEC			
Hr. izol. (mm)	Rola (šírka 1m) Obj. kód	m <sup>2</sup> / bal.	EUR/m <sup>2</sup> bez DPH
10	ALU-TEC 10	20	47,00 €
13	ALU-TEC 13	14	49,70 €
19	ALU-TEC 19	10	52,55 €
25	ALU-TEC 25	8	64,25 €
32	ALU-TEC 32	6	67,40 €

Samolepiace izolačné pásy s povrchom PROTECT ALU-TEC.

Kaiflex Protect ALU-TEC (SA)			
Hr. izol. (mm)	Rola (šírka 1m) Obj. kód	m <sup>2</sup> / bal.	EUR/m <sup>2</sup> bez DPH
10	ALU-TEC 10 -SA	20	47,00 €
13	ALU-TEC 13 -SA	14	49,70 €
19	ALU-TEC 19 -SA	10	52,55 €
25	ALU-TEC 25 -SA	8	64,25 €
32	ALU-TEC 32 -SA	6	67,40 €

## TRUBICE KAIFLEX EPDM plus



Ohybný izolačný elastomerový materiál na báze EPDM. Izolácia čiernej farby s mimoriadnou odolnosťou proti UV žiareniu a vysokým teplotám. Izolácia sa používa prevažne na izolovanie rozvodov solárnych aplikácií vo vonkajšom prostredí. Rozsah použitia od -50°C do +175°C (stála prevádzková teplota do +150°C). Lepiť len lepidlom Kaiflex EPDM na solar. Dĺžka trubice 2m. Faktor dif. odporu  $\mu > 4500$ , súčiniteľ tepelnej vodivosti  $\lambda_{0^\circ\text{C}} = 0,038 \text{ W/m.K}$ . Trieda reakcie na oheň E.



Vonk. Ø potr. (mm)	Kaiflex EPDM plus			Kaiflex EPDM plus			Kaiflex EPDM plus			Kaiflex EPDM plus			Kaiflex EPDM plus		
	Hr. izolácie 10 mm			Hr. izolácie 13 mm			Hr. izolácie 19 mm			Hr. izolácie 25 mm			Hr. izolácie 32 mm		
	Obj. kód	bm/ bal.	EUR/bm bez DPH	Obj. kód	bm/ bal.	EUR/bm bez DPH	Obj. kód	bm/ bal.	EUR/bm bez DPH	Obj. kód	bm/ bal.	EUR/bm bez DPH	Obj. kód	bm/ bal.	EUR/bm bez DPH
10	010 / 10	220	4,10 €	010 / 13	152	4,40 €									
12	012 / 10	190	4,30 €	012 / 13	136	4,65 €	012 / 19	78	8,10 €	012 / 25	50	13,40 €	012 / 32	32	18,10 €
15	015 / 10	172	4,45 €	015 / 13	120	5,30 €	015 / 19	72	9,75 €	015 / 25	50	14,90 €	015 / 32	32	20,10 €
18	018 / 10	136	4,80 €	018 / 13	106	5,70 €	018 / 19	60	10,05 €	018 / 25	40	15,20 €	018 / 32	24	20,45 €
22	022 / 10	112	5,30 €	022 / 13	84	6,25 €	022 / 19	56	11,50 €	022 / 25	36	16,55 €	022 / 32	24	22,30 €
28	028 / 10	84	5,95 €	028 / 13	72	6,75 €	028 / 19	40	13,70 €	028 / 25	32	18,85 €	028 / 32	22	25,45 €
35	035 / 10	60	6,70 €	035 / 13	50	8,20 €	035 / 19	36	15,85 €	035 / 25	24	21,25 €	035 / 32	18	28,70 €
42	042 / 10	50	7,65 €	042 / 13	40	9,15 €	042 / 19	32	17,90 €	042 / 25	22	23,30 €	042 / 32	18	31,45 €
48	048 / 10	40	8,90 €	048 / 13	36	11,00 €	048 / 19	24	21,80 €	048 / 25	18	27,05 €	048 / 32	14	36,45 €
54	054 / 10	36	10,45 €	054 / 13	32	13,20 €	054 / 19	22	24,65 €	054 / 25	18	29,95 €	054 / 32	12	40,40 €
60	060 / 10	32	12,95 €	060 / 13	24	14,50 €	060 / 19	18	27,55 €	060 / 25	16	33,00 €	060 / 32	12	44,55 €
76	076 / 10	20	16,90 €	076 / 13	18	15,50 €	076 / 19	16	34,00 €	076 / 25	12	39,35 €	076 / 32	8	53,10 €
89	089 / 10	18	18,75 €	089 / 13	16	21,65 €	089 / 19	12	37,50 €	089 / 25	12	42,70 €	089 / 32	8	57,65 €

## PÁSY KAIFLEX EPDM plus

Pásky zo syntetického kaučuku.



Kaiflex EPDM plus			
Hr. izol. (mm)	Rola (šírka 1m) Obj. kód	m <sup>2</sup> /bal.	EUR/m <sup>2</sup> bez DPH
6	EPDM plus 06	18	35,10 €
10	EPDM plus 10	10	53,40 €
13	EPDM plus 13	8	64,55 €
19	EPDM plus 19	6	85,95 €
25	EPDM plus 25	4	104,20 €
32	EPDM plus 32	3	125,05 €

## TRUBICE TUBOLIT S



izolačné trubice z polyetylénu a s PE fóliou pre zvýšenú ochranu potrubia (modrá alebo červená farba). Dĺžka trubice 2m.

Vonk. Ø potr. (mm)	Tubolit S BLUE				Tubolit S BLUE			Tubolit S BLUE			Tubolit S BLUE		
	Hr. izolácie 9 mm				Hr. izolácie 13 mm			Hr. izolácie 20 mm			Hr. izolácie 25 mm		
	Obj. kód	bm/ bal.	EUR/bm bez DPH		Obj. kód	bm/ bal.	EUR/bm bez DPH	Obj. kód	bm/ bal.	EUR/bm bez DPH	Obj. kód	bm/ bal.	EUR/bm bez DPH
15	015 / 9	234	1,02 €		015 / 13	234	2,00 €				015 / 25	66	4,30 €
18	018 / 9	214	1,06 €		018 / 13	214	2,10 €				018 / 25	56	4,62 €
22	022 / 9	178	1,14 €		022 / 13	178	2,26 €				022 / 25	54	5,12 €
28	028 / 9	130	1,22 €		028 / 13	130	2,48 €	028 / 20	60	3,76 €	028 / 25	56	5,48 €
35	035 / 9	96	1,58 €		035 / 13	96	3,20 €	035 / 20	56	4,10 €			
42	042 / 9	72	1,82 €		042 / 13	72	3,92 €	042 / 20	40	4,60 €			

Vonk. Ø potr. (mm)	Tubolit S RED			Tubolit S RED		
	Hr. izolácie 9 mm			Hr. izolácie 13 mm		
	Obj. kód	bm/ bal.	EUR/bm bez DPH	Obj. kód	bm/ bal.	EUR/bm bez DPH
15	015 / 9	234	1,02 €	015 / 13	234	2,00 €
18	018 / 9	214	1,06 €	018 / 13	214	2,10 €
22	022 / 9	178	1,14 €	022 / 13	178	2,26 €
28	028 / 9	130	1,22 €	028 / 13	130	2,48 €
35	035 / 9	96	1,58 €	035 / 13	96	3,20 €
42	042 / 9	72	1,82 €			

## HADICE TUBOLIT S PLUS



Návleková izolácia z polyetylénu a s PE fóliou na ochranu potrubia v stene alebo podlahe (modrá alebo červená farba). Dĺžka hadice 20m.

Vonk. Ø (mm)	Tubolit S+ BLUE			
	Hr. izolácie 4 mm			
	Obj. kód	bm/ bal.	EUR/bm bez DPH	EUR/ks bez DPH
15	015 / 4	520	0,62 €	12,40 €
18	018 / 4	440	0,66 €	13,20 €
22	022 / 4	400	0,68 €	13,60 €
28	028 / 4	320	0,76 €	15,20 €
35	035 / 4	280	0,80 €	16,00 €
42	042 / 4	240	0,90 €	18,00 €

Vonk. Ø (mm)	Tubolit S+ RED			
	Hr. izolácie 4 mm			
	Obj. kód	bm/ bal.	EUR/bm bez DPH	EUR/ks bez DPH
15	015 / 4	520	0,62 €	12,40 €
18	018 / 4	440	0,66 €	13,20 €
22	022 / 4	400	0,68 €	13,60 €
28	028 / 4	320	0,76 €	15,20 €

## TRUBICE TUBOLIT DG



Izolačný materiál na báze polyetylénu šedej farby určený k izolovaniu potrubia kúrenia a sanity.

Izolácia výrazne znižuje energetické straty až o 80%. Dĺžka trubice 2m.

Rozsah použitia do +100°C. Súčiniteľ tepelnej vodivosti  $\lambda^{\circ}\text{C} = 0,040 \text{ W/m.K}$ . Trieda reakcie na oheň E.

Vonk. Ø potr. (mm)	Tubolit DG			Tubolit DG			Tubolit DG			Tubolit DG		
	Hr. izolácie 5 mm			Hr. izolácie 9 mm			Hr. izolácie 13 mm			Hr. izolácie 20 mm		
	Obj. kód	bm/ bal.	EUR/bm bez DPH	Obj. kód	bm/ bal.	EUR/bm bez DPH	Obj. kód	bm/ bal.	EUR/bm bez DPH	Obj. kód	bm/ bal.	EUR/bm bez DPH
12	012 / 5	520	0,30 €									
15	015 / 5	390	0,34 €	015 / 9	262	0,58 €	015 / 13	192	0,88 €	015 / 20	100	1,54 €
18	018 / 5	280	0,38 €	018 / 9	230	0,60 €	018 / 13	156	0,94 €	018 / 20	88	1,64 €
20	020 / 5	280	0,40 €	020 / 9	212	0,62 €	020 / 13	140	0,98 €			
22	022 / 5	240	0,42 €	022 / 9	182	0,66 €	022 / 13	140	1,02 €	022 / 20	80	1,88 €
25	025 / 5	230	0,46 €	025 / 9	138	0,70 €	025 / 13	124	1,10 €			
28	028 / 5	180	0,48 €	028 / 9	136	0,74 €	028 / 13	108	1,14 €	028 / 20	68	2,20 €
32	032 / 5	170	0,64 €	032 / 9	122	0,86 €	032 / 13	90	1,38 €			
35	035 / 5	140	0,74 €	035 / 9	102	0,96 €	035 / 13	88	1,60 €	035 / 20	50	2,42 €
40				040 / 9	82	1,04 €	040 / 13	70	1,78 €			
42				042 / 9	72	1,06 €	042 / 13	60	1,88 €	042 / 20	44	2,80 €
48				048 / 9	70	1,26 €	048 / 13	60	2,08 €	048 / 20	40	4,12 €
50				050 / 9	66	1,38 €	050 / 13	56	2,16 €			
54				054 / 9	60	1,62 €	054 / 13	50	2,40 €	054 / 20	32	4,14 €
60				060 / 9	52	1,78 €	060 / 13	38	2,48 €	060 / 20	28	4,30 €
64				064 / 9	50	2,06 €	064 / 13	32	2,68 €	064 / 20	26	4,66 €
76				076 / 9	32	2,50 €	076 / 13	26	3,20 €	076 / 20	20	5,06 €
89				089 / 9	22	2,88 €	089 / 13	22	3,94 €	089 / 20	18	8,38 €
110							110 / 13	16	5,26 €	110 / 20	12	10,88 €
114							114 / 13	12	5,58 €	114 / 20	12	11,20 €

Vonk. Ø potr. (mm)	Tubolit DG			Tubolit DG		
	Hr. izolácie 25 mm			Hr. izolácie 30 mm		
	Obj. kód	bm/ bal.	EUR/bm bez DPH	Obj. kód	bm/ bal.	EUR/bm bez DPH
15	015 / 25	66	2,74 €			
18	018 / 25	56	2,90 €	018 / 30	56	3,42 €
22	022 / 25	54	3,34 €	022 / 30	46	3,64 €
28	028 / 25	56	3,66 €	028 / 30	40	3,76 €
35	035 / 25	32	4,04 €	035 / 30	34	4,24 €
42	042 / 25	28	4,62 €	042 / 30	26	4,86 €
48	048 / 25	24	5,04 €	048 / 30	22	5,34 €
54	054 / 25	24	5,50 €	054 / 30	22	5,82 €
60	060 / 25	24	6,22 €	060 / 30	18	6,74 €
64				064 / 30	18	7,80 €
76	076 / 25	16	7,30 €	076 / 30	16	9,50 €
89	089 / 25	14	11,18 €	089 / 30	10	12,28 €
114	114 / 25	8	13,68 €	114 / 30	8	14,84 €

## HADICE TUBOLIT AR Fonoblok

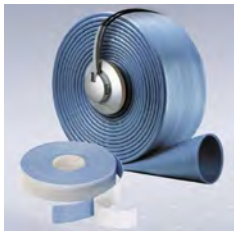

Návleková izolácia pre oceľové potrubia odpadovej vody a dažďových zvodov (útlm hluku, ochrana proti kondenzácii). Dĺžka hadice 15m.

<b>Tubolit AR</b>				
Hr. izolácie 5 mm				
Vonk. Ø (mm)	Obj. kód	bm/bal.	EUR/bm bez DPH	EUR/ks bez DPH
58	AR 050/5	135	1,10 €	16,50 €
78	AR 070/5	105	1,48 €	22,20 €
90	AR 090/5	75	1,62 €	24,30 €
110	AR 0100/5	75	1,88 €	28,20 €
135	AR 125/5	60	2,22 €	33,30 €
160	AR 150/5	45	2,68 €	40,20 €

## HADICE TUBOLIT ARW Fonowave



Návleková izolácia PVC potrubia odpadovej vody a dažďových zvodov (útlm hluku, ochrana proti kondenzácii). Dĺžka hadice 10m.

<b>Tubolit ARW</b>				
Hr. izolácie 9 mm				
Vonk. Ø (mm)	Obj. kód	bm/bal.	EUR/bm bez DPH	EUR/ks bez DPH
58	ARW 050/9	80	2,32 €	23,20 €
78	ARW 070/9	60	3,08 €	30,80 €
90	ARW 090/9	50	3,60 €	36,00 €
110	ARW 100/9	50	3,84 €	38,40 €
135	ARW 125/9	40	4,70 €	47,00 €



**Mirelon POLAR** - izolácia z penového polyetylénu laminovaná zosílenou hliníkovou fóliou. Vhodný pre použitie v priestoroch, ktoré je nutné z hygienických dôvodov umývať. Dĺžka trubice 2m. Rozsah použitia do +90°C. Súčiniteľ tepelnej vodivosti  $\lambda_{10^\circ\text{C}} = 0,046 \text{ W/m.K}$ . Trieda reakcie na oheň E.

Vonk. Ø potr. (mm)	Mirelon POLAR			Mirelon POLAR			Mirelon POLAR			Mirelon POLAR		
	Hr. izolácie 9 mm			Hr. izolácie 13 mm			Hr. izolácie 20 mm			Hr. izolácie 25 mm		
	Obj. kód	bm/ bal.	EUR/bm bez DPH	Obj. kód	bm/ bal.	EUR/bm bez DPH	Obj. kód	bm/ bal.	EUR/bm bez DPH	Obj. kód	bm/ bal.	EUR/bm bez DPH
12	012 / 9	520	1,60 €	012 / 13	260	2,00 €						
15	015 / 9	400	1,70 €	015 / 13	250	2,20 €	015 / 20	160	4,10 €			
18	018 / 9	370	1,80 €	018 / 13	240	2,40 €	018 / 20	140	4,40 €			
20	020 / 9	320	2,00 €	020 / 13	204	3,10 €	020 / 20	126	5,50 €			
22	022 / 9	280	2,00 €	022 / 13	204	3,10 €	022 / 20	120	5,50 €	022 / 25	80	7,50 €
25	025 / 9	216	2,50 €	025 / 13	160	3,40 €	025 / 20	90	6,40 €	025 / 25	68	9,10 €
28	028 / 9	216	2,50 €	028 / 13	160	3,40 €	028 / 20	90	6,40 €	028 / 25	68	9,10 €
32	032 / 9	198	3,00 €	032 / 13	120	4,20 €	032 / 20	80	7,30 €	032 / 25	66	11,10 €
35	035 / 9	168	3,20 €	035 / 13	108	4,50 €	035 / 20	80	8,00 €	035 / 25	60	12,20 €
40	040 / 9	130	3,60 €	040 / 13	94	5,10 €	040 / 20	66	8,50 €	040 / 25	54	13,50 €
45	045 / 9	120	3,70 €	045 / 13	90	5,50 €	045 / 20	66	9,00 €	045 / 25	46	14,90 €
48	048 / 9	90	4,00 €	048 / 13	84	5,70 €	048 / 20	60	9,40 €	048 / 25	42	17,00 €
50	050 / 9	90	4,20 €	050 / 13	80	6,10 €	050 / 20	60	10,10 €	050 / 25	42	19,00 €
54	054 / 9	90	4,40 €	054 / 13	70	6,40 €	054 / 20	48	10,50 €	054 / 25	40	20,50 €
60	060 / 9	70	4,60 €	060 / 13	60	6,50 €	060 / 20	40	10,70 €	060 / 25	32	21,70 €
64	064 / 9	70	5,10 €	064 / 13	60	6,80 €	064 / 20	40	11,20 €	064 / 25	32	24,50 €
76	076 / 9	48	6,00 €	076 / 13	40	8,70 €	076 / 20	30	13,40 €	076 / 25	26	34,80 €
89				089 / 13	30	9,90 €	089 / 20	24	14,50 €	089 / 25	20	42,00 €
108				108 / 13	24	13,00 €	108 / 20	20	20,00 €	108 / 25	16	51,00 €
110				110 / 13	24	14,40 €	110 / 20	18	23,40 €	110 / 25	14	55,10 €
134				134 / 13			134 / 20	12	29,00 €	134 / 25	12	62,90 €



## TRUBICE Mirelon STABIL



**Mirelon STABIL**- izolácia z penového polyetylénu laminované polyetylénovou tkaninou (modrá, červená a biela farba).

Dĺžka trubice 2m. Rozsah použitia do +90°C. Súčiniteľ tepelnej vodivosti  $\lambda_{10^\circ\text{C}} = 0,046 \text{ W/m.K}$ . Trieda reakcie na oheň E.

Vonk. Ø potr. (mm)	Mirelon STABIL			Mirelon STABIL			Mirelon STABIL			Mirelon STABIL		
	Hr. izolácie 9 mm			Hr. izolácie 13 mm			Hr. izolácie 20 mm			Hr. izolácie 25 mm		
	Obj. kód	bm/ bal.	EUR/bm bez DPH	Obj. kód	bm/ bal.	EUR/bm bez DPH	Obj. kód	bm/ bal.	EUR/bm bez DPH	Obj. kód	bm/ bal.	EUR/bm bez DPH
12				012 / 13	260	1,90 €						
15				015 / 13	250	2,10 €	015 / 20	160	4,10 €			
18				018 / 13	240	2,40 €	018 / 20	140	4,30 €			
20				020 / 13	204	3,00 €	020 / 20	126	5,50 €			
22	022 / 9	280	2,00 €	022 / 13	204	3,00 €	022 / 20	120	5,50 €	022 / 25	80	6,40 €
25	025 / 9	216	2,50 €	025 / 13	160	3,40 €	025 / 20	90	6,30 €	025 / 25	68	7,70 €
28	028 / 9	216	2,50 €	028 / 13	160	3,40 €	028 / 20	90	6,30 €	028 / 25	68	7,70 €
32	032 / 9	198	2,90 €	032 / 13	120	4,10 €	032 / 20	80	7,20 €	032 / 25	66	9,20 €
35	035 / 9	168	3,20 €	035 / 13	108	4,50 €	035 / 20	80	7,90 €	035 / 25	60	10,00 €
40	040 / 9	130	3,60 €	040 / 13	94	5,10 €	040 / 20	66	8,40 €	040 / 25	54	10,90 €
45	045 / 9	120	3,70 €	045 / 13	90	5,50 €	045 / 20	66	8,90 €	045 / 25	46	11,90 €
48	048 / 9	90	4,00 €	048 / 13	84	5,70 €	048 / 20	60	9,30 €	048 / 25	42	13,60 €
50	050 / 9	90	4,10 €	050 / 13	80	6,00 €	050 / 20	60	10,00 €	050 / 25	42	15,00 €
54	054 / 9	90	4,30 €	054 / 13	70	6,40 €	054 / 20	48	10,40 €	054 / 25	40	16,10 €
60	060 / 9	70	4,60 €	060 / 13	60	6,40 €	060 / 20	40	10,60 €	060 / 25	32	17,20 €
64	064 / 9	70	5,00 €	064 / 13	60	6,70 €	064 / 20	40	11,10 €	064 / 25	32	19,30 €
76	076 / 9	48	5,90 €	076 / 13	40	8,60 €	076 / 20	30	13,30 €	076 / 25	26	28,40 €
89				089 / 13	30	9,80 €	089 / 20	24	14,40 €	089 / 25	20	35,10 €
108				108 / 13	24	12,90 €	108 / 20	20	19,20 €	108 / 25	16	42,60 €
110				110 / 13	24	14,20 €	110 / 20	18	22,50 €	110 / 25	14	45,80 €
134							134 / 20	12	27,90 €	134 / 25	12	52,70 €

## PÁSY PE



Izolačné pásy z polyetylénu určené na izolovanie kúrenia, sanity, nádrží, vzduchotechniky a pod.

Pásy - v šedej farbe.

<b>PE pás</b> (bez povrchovej úpravy)				<b>PE pás</b> (bez povrchovej úpravy, samolep)			
Hr. izol. (mm)	Rola (šírka 1m) Obj. kód	m <sup>2</sup> / bal.	EUR/m <sup>2</sup> bez DPH	Hr. izol. (mm)	Rola (šírka 1m) Obj. kód	m <sup>2</sup> / bal.	EUR/m <sup>2</sup> bez DPH
5*	PE 5 *	-	2,90 €	5*	PE 5 -SA	-	11,80 €
10	PE 10	20	5,80 €	10	PE 10 -SA	20	15,15 €
15	PE 15	20	8,70 €	15	PE 15 -SA	20	18,45 €
20	PE 20	20	11,55 €	20	PE 20 -SA	20	21,80 €
25	PE 25	-	14,45 €	25	PE 25 -SA	-	25,15 €
30	PE 30	-	17,35 €	30	PE 30 -SA	-	28,50 €

\* šírka pásov 1 alebo 1,1m

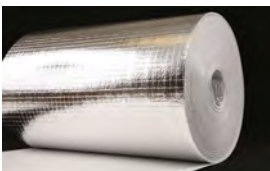

Pásy - v bielej alebo šedej farbe.

<b>PE pás</b> (AL - hliníková fólia)				<b>PE pás</b> (AL - hliníková fólia, samolep)			
Hr. izol. (mm)	Rola (šírka 1m) Obj. kód	m <sup>2</sup> / bal.	EUR/m <sup>2</sup> bez DPH	Hr. izol. (mm)	Rola (šírka 1m) Obj. kód	m <sup>2</sup> / bal.	EUR/m <sup>2</sup> bez DPH
5	PE AL 5	50	4,65 €	5	PE AL 5 -SA	50	13,10 €
10	PE AL 10	20	7,55 €	10	PE AL 10 -SA	20	16,00 €
15	PE AL 15	20	10,40 €	15	PE AL 15 -SA	20	18,90 €
20	PE AL 20	20	13,30 €	20	PE AL 20 -SA	20	21,70 €
25	PE AL 25	-	16,15 €	25	PE AL 25 -SA	-	24,60 €
30	PE AL 30	-	19,00 €	30	PE AL 30 -SA	-	27,45 €

<b>PE pás</b> (PET - polyetylentereftalátová reflexná fólia)			
Hr. izol. (mm)	Rola (šírka 0,7m) Obj. kód	m / bal.	EUR/m <sup>2</sup> bez DPH
2	PE PET 2	25	2,50 €
3	PE PET 3	25	2,90 €



Hlukoizolácia potrubia odpadovej vody.

### APLOMB 11

Hr. izol. (mm)	Rola (šírka 1m) Obj. kód	m <sup>2</sup> /bal.	EUR/m <sup>2</sup> bez DPH
15	APLOMB 11	3	78,00 €

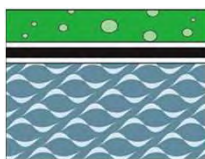

- Vrstva chemicky zosietenej PE peny hr. 3mm, kaširovaná kovovo naparenou čiernou fóliou.
- Olovená platňa hrúbky 0,35 mm (4 kg/m<sup>2</sup>).
- Chemicky zosietená polyetylénová vrstva peny hrúbky 12 mm.

Hlukoizolácia stien a pod.

### APLOMB 22

Hr. izol. (mm)	Rola (šírka 1m) Obj. kód	m <sup>2</sup> /bal.	EUR/m <sup>2</sup> bez DPH
6	APLOMB 22	3	81,00 €



- Vrstva chemicky zosietenej PE peny, kaširovaná kovovo naparenou čiernou fóliou hrúbky 3mm.
- Olovená platňa hrúbky 0,35 mm (4 kg/m<sup>2</sup>).
- Vrstva chemicky zosietenej PE peny, kaširovaná kovovo naparenou čiernou fóliou hrúbky 3mm.
- CL1 - povrchová úprava s čiernou tkaninou

# ArmaComfort®

VYSOKO FLEXIBILNÝ AKUSTICKÝ KOMFORT



- Špeciálne navrhnutý pre znižovanie hluku rozvodov dažďovej vody a kanalizačného potrubia.
- Tenká akustická izolácia s výbornými vlastnosťami
- Jednoduchá montáž a údržba



## REDUKCIA HLUKU

**Zvuk** je mechanická vibrácia, ktorá je ľudským ušom vnímaná vo frekvenčnom rozsahu od 16 Hz do 16 000 Hz.

Frekvencia je počet vibrácií za sekundu. Výška rastie so zvyšujúcou frekvenciou. Pri akustike budov je najdôležitejší rozsah 100 Hz a 3 150 Hz.

**Útlm** je nameraný rozdiel v hladine hluku medzi neizolovaným potrubím a potrubím s izoláciou. Táto nameraná hodnota zníženia hluku v dB(A) poskytuje priamu informáciu o zlepšení útlmu - pri použití akustickej izolácie.

## Bel (B) a decibel (dB)

sú relatívne jednotky a predstavujú pomer medzi dvoma akustickými hodnotami na logaritmickom meradle.

## Decibel (A), dB (A)

váži hlasitosť podľa frekvencie. Týmto spôsobom je možné dosiahnuť merateľné vyjadrenie vnímaného hluku. V závislosti od frekvencie vníma ľudské ucho tóny rovnakého zvukového tlaku ako rôzne silný zvuk.

## PÁSY ArmaComfort



Špeciálny typ izolácie pre znižovanie hluku rozvodov dažďovej vody a odpadového potrubia. Súčiniteľ tepelnej vodivosti  $\lambda_{10^{\circ}\text{C}} = 0,040\text{W/m.K}$ .  $R_w=26\text{dB}$ . Redukcia hluku prenášaného konštrukciou:  
na plastových potrubiach  $\leq 14\text{ dB (A)}$   
na systéme Geberit PE HD  $\leq 16\text{ dB (A)}$   
na systéme Geberit Silent db20  $\leq 18\text{ dB (A)}$ .

### ArmaComfort AB

Hr. izol. (mm)	Rola (šírka 1m) Obj. kód	$m^2/\text{bal.}$	EUR/m <sup>2</sup> bez DPH
11	AO-11-99/E-AB	2	53,25 €



Špeciálny typ izolácie pre znižovanie hluku rozvodov dažďovej vody, kanalizácie a odpadového potrubia. Je špeciálne určený pre neobytné budovy ako sú napr. kancelárie, hotely, nemocnice, školy, nákupné a kongresové centrá. Izolácia sa skladá z akustickej bariéry (EPDMA-eva peny) v hr. 2mm, ktorá ma na povrchu AL fóliou a z polyuretánovej peny hr. 10mm. Trieda reakcie na oheň B s1,d0. Súčiniteľ tepelnej vodivosti  $\lambda_{10^{\circ}\text{C}} = 0,040\text{ W/m.K}$ .  $R_w=28\text{dB}$ .

### ArmaComfort AB ALU

Hr. izol. (mm)	Rola (šírka 1m) Obj. kód	$m^2/\text{bal.}$	EUR/m <sup>2</sup> bez DPH
12	AO-12-99/E-AB-AL	2	59,95 €



Špeciálny typ izolácie pre znižovanie hluku rozvodov dažďovej vody, kanalizácie a odpadového potrubia. Je vhodný na použitie v obytných a neobytných budovách pre zvýšenie bezpečnosti a zabránenie vzniku korózie. Izolácia sa skladá z akustickej bariéry (EPDMA-eva peny) v hr. 2mm, ktorá ma na povrchu AL fóliou a z elastomerickej peny Armaflex hr. 9mm. Trieda reakcie na oheň B s1,d0. Súčiniteľ tepelnej vodivosti  $\lambda_{10^{\circ}\text{C}} = 0,042\text{ W/m.K}$ .

Redukcia hluku prenášaného konštrukciou: na systéme Geberit Silent db20  $\leq 18\text{ dB (A)}$ .

### ArmaComfort AB ALU PLUS

Hr. izol. (mm)	Rola (šírka 1m) Obj. kód	$m^2/\text{bal.}$	EUR/m <sup>2</sup> bez DPH
11	AO-11-99/E-AB-AL+	2	63,50 €
11	AO-11-99/E25-AB-AL+	25	61,25 €

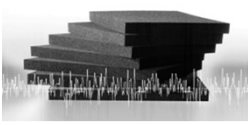

Izolácia KAISOUND sa používa v priemyselných komplexoch a obytných budovách na účinné tlmenie hluku. Používa sa aj k odstráneniu tzv. štruktúrného hluku, ktorý sa šíri stenami, podlahami alebo konštrukciami v budovách. Správnym výberom typu izolácie (obj.hmotnosti 120 alebo 240kg/m<sup>3</sup>) je možné systém izolácie presne prispôbiť konkrétnemu prostrediu, intenzite a frekvencii hluku.

<b>Kaisound 140 SA (samolep)</b>			
Hr. izol. (mm)	(1,2x0,84m) Obj.kód	m <sup>2</sup> /bal.	EUR/m <sup>2</sup> bez DPH
6	KS140-06 SA M	16	32 €
10	KS140-10 SA M	10	46 €
15	KS140-15 SA M	6	64 €
20	KS140-20 SA M	5	81 €
25	KS140-25 SA M	4	97 €
50	KS140-50 SA M	2	183 €

<b>Kaisound 240 SA (samolep)</b>			
Hr. izol. (mm)	(1,2x0,84m) Obj.kód	m <sup>2</sup> /bal.	EUR/m <sup>2</sup> bez DPH
6	KS240-06 SA M	16	39 €
10	KS240-10 SA M	10	58 €
15	KS240-15 SA M	6	82 €
20	KS240-20 SA M	5	104 €
25	KS240-25 SA M	4	126 €
50	KS240-50 SA M	2	241 €

## PÁSY Kaivenience



Hydrofóbný a flexibilný izolačný materiál s otvorenými bunkami na báze syntetického kaučuku s ťažkou bezolovnatou fóliou na báze polyméru (vyplnená anorganickými materiálmi).  
Súčiniteľ tepelnej Redukcia hluku prenášaného konštrukciou: na plastových potrubiach  $\leq 15$  dB (A).  
Trieda reakcie na oheň E.



### Kaivenience AB

Hr. izol. (mm)	Rola (1,18 x 0,83 m) Obj. kód	m <sup>2</sup> /bal.	EUR/m <sup>2</sup> bez DPH
5	AB-05	2,94	35,00 €
10	AB-10	1,96	36,00 €

### Kaivenience AB SA (samolep)

Hr. izol. (mm)	Rola (1,18 x 0,83 m) Obj. kód	m <sup>2</sup> /bal.	EUR/m <sup>2</sup> bez DPH
5	AB-05 SA	19,6	42,00 €
10	AB-10 SA	9,8	43,00 €



Špeciálny typ izolácie pre znižovanie hluku rozvodov dažďovej vody, kanalizácie a odpadového potrubia. Je vhodný na použitie v obytných a neobytných budovách pre zvýšenie bezpečnosti a zabránenie vzniku korózie.  
Hydrofóbný a flexibilný izolačný materiál s otvorenými bunkami na báze syntetického kaučuku s ťažkou bezolovnatou fóliou na báze polyméru (vyplnená anorganickými materiálmi) a ALU fóliou zosilneniu sklotextilnou mriežkou.  
Redukcia hluku prenášaného konštrukciou: na plastových potrubiach  $\leq 15$  dB (A).  
Trieda reakcie na oheň D s2,d0.

### Kaivenience AB ALU

Hr. izol. (mm)	Rola (1,18 x 0,83 m) Obj. kód	m <sup>2</sup> /bal.	EUR/m <sup>2</sup> bez DPH
5	AB-05-ALU	2,94	38,00 €
10	AB-10-ALU	1,96	40,00 €

### Kaivenience AB ALU SA (samolep)

Hr. izol. (mm)	Rola (1,18 x 0,83 m) Obj. kód	m <sup>2</sup> /bal.	EUR/m <sup>2</sup> bez DPH
5	AB-05-ALU SA	19,6	45,00 €
10	AB-10-ALU SA	9,8	47,00 €

## LAMELOVÉ PÁSY s ALS fóliou "ML3"

Lamelový izolačný pás zo skleneného vlákna nalepený na hliníkovú fóliu vystuženú sklotextilnou mriežkou.

CLIMCOVER				Ventilam ALU/ML-3			
hr. (mm)	EUR/m2 bez DPH	m <sup>2</sup> / bal.	m <sup>2</sup> / pal.	hr. (mm)	EUR/m2 bez DPH	m <sup>2</sup> / bal.	m <sup>2</sup> / pal.
20	8,95 €	12	144	20	8,80 €	14,4	172,8
30	11,40 €	9,6	115,2	30	11,10 €	9,6	115,2
40	13,45 €	7,2	86,4	40	13,15 €	7,2	86,4
50	15,45 €	6	72	50	15,15 €	6	72
60	18,40 €	4,8	57,6	60	17,95 €	4,8	57,6
80	23,05 €	3,6	43,2	80	22,75 €	3,6	43,2
100	27,85 €	3	36	100	27,70 €	3	36

Max. 250 °C. Šírka 2x0,6m.

Max. 250 °C. Šírka 1,2m.

Ventilam ALU/ML-3 PLUS			
hr. (mm)	EUR/m2 bez DPH	m <sup>2</sup> / bal.	m <sup>2</sup> / pal.
20	10,50 €	12	144
30	13,30 €	8	96
40	16,25 €	6	72
50	17,95 €	5	60

Pás so samolepiacou vrstvou.

Max.50 °C. Šírka 1m.

## LAMELOVÉ PÁSY s ALS fóliou "LSP"

Lamelový izolačný pás z čadičovej vlny nalepený na hliníkovú fóliu vystuženú sklotextilnou mriežkou.

Orstech LSP 40 (40kg/m <sup>3</sup> )				Orstech LSP H (55kg/m <sup>3</sup> )				Orstech LSP PYRO (65kg/m <sup>3</sup> )			
hr. (mm)	EUR/m2 bez DPH	m <sup>2</sup> / bal.	m <sup>2</sup> / pal.	hr. (mm)	EUR/m2 bez DPH	m <sup>2</sup> / bal.	m <sup>2</sup> / pal.	hr. (mm)	EUR/m2 bez DPH	m <sup>2</sup> / bal.	m <sup>2</sup> / pal.
20	8,95 €	8	160	20	9,70 €	8	160				
30	10,80 €	5	100	30	11,90 €	5	100	30	12,20 €	5	105
40	12,80 €	4	80	40	14,35 €	4	80	40	14,35 €	5	84
50	15,00 €	3	60	50	17,00 €	3	60	50	17,00 €	4 (3)	63
60	16,70 €	3	60	60	18,25 €	3	63	60	19,00 €	4	63
80	20,70 €	2	40	80	23,20 €	2	40	80	24,60 €	3	42
100	25,35 €	2,3	41,4	100	27,40 €	2,3	41,4	100	29,40 €	2,8	36

Max.250°C. Šírka 1m.

Max.620°C. Šírka 1m.

Max.620°C. Šírka 1m.



## ROHOŽE s drôteným pletivom



TECH Wired Mat MT 4.0 (DE)				TECH Wired Mat MT 5.0 (DE)			
hr. (mm)	EUR/m2 bez DPH	m <sup>2</sup> / bal.	m <sup>2</sup> / pal.	hr. (mm)	EUR/m2 bez DPH	m <sup>2</sup> / bal.	m <sup>2</sup> / pal.
30	16,85 €	4	180	30	20,25 €	4	160
40	20,70 €	4	160	40	24,15 €	4	120
50	25,05 €	2,5	112,5	50	26,60 €	2,5	100
60	29,40 €	2,5	100	60	31,60 €	2,5	75
70	32,95 €	2	100	70	36,40 €	2,5	75
80	36,85 €	2	80	80	39,65 €	2	60
90	40,40 €	2	60	90	45,55 €	2	60
100	42,10 €	2	60	100	54,70 €	1,5	45
120	51,75 €	2	40	120	63,05 €	1,5	45

Max 600°C. Šírka 0,5m

Max 620°C. Šírka 0,5m

TECH Wired Mat MT 3.1 (DE)				TECH Wired Mat MT 4.1 (PL)				TECH Wired Mat MT 5.1 (PL)				TECH Wired Mat MT 6.1 (PL)			
hr. (mm)	EUR/m2 bez DPH	m <sup>2</sup> / bal.	m <sup>2</sup> / pal.	hr. (mm)	EUR/m2 bez DPH	m <sup>2</sup> / bal.	m <sup>2</sup> / pal.	hr. (mm)	EUR/m2 bez DPH	m <sup>2</sup> / bal.	m <sup>2</sup> / pal.	hr. (mm)	EUR/m2 bez DPH	m <sup>2</sup> / bal.	m <sup>2</sup> / pal.
50	19,65 €	5	105	30	16,85 €	6	126	30	20,25 €	6	126	50	30,80 €	4	84
60	23,20 €	5	105	40	20,70 €	5,5	115,5	40	24,15 €	5	105	80	45,55 €	2,5	52,5
80	28,45 €	4	84	50	25,05 €	4	84	50	26,60 €	4	84	100	55,60 €	2	42
100	34,85 €	2,5	52,5	60	29,40 €	3,5	73,5	60	31,60 €	3	63	120	65,05 €	2	42
120	41,65 €	2,5	52,5	70	32,95 €	3,5	73,5	70	36,40 €	2,5	52,5	Max 700°C. Šírka 1m			
Max 560°C. Šírka 1m				80	36,85 €	3	63	80	39,65 €	2,5	52,5	Max 660°C. Šírka 1m			
				90	40,40 €	2,5	52,5	90	45,55 €	2	42				
				100	42,10 €	2,5	52,5	100	54,70 €	2	42				
				120	51,75 €	2	42	120	63,05 €	2	42				



## DOSKY



Orstech 45				Orstech 65				Orstech 100			
hr. (mm)	EUR/m2 bez DPH	m <sup>2</sup> / bal.	m <sup>2</sup> / pal.	hr. (mm)	EUR/m2 bez DPH	m <sup>2</sup> / bal.	m <sup>2</sup> / pal.	hr. (mm)	EUR/m2 bez DPH	m <sup>2</sup> / bal.	m <sup>2</sup> / pal.
40	7,85 €	6	60	40	10,95 €	6	60	40	15,60 €	6	60
50	9,70 €	5	50	50	13,30 €	5	50	50	19,65 €	4	50
60	11,75 €	4	40	60	15,90 €	4	40	60	23,35 €	4	40
80	15,75 €	3	30	80	21,05 €	3	30	80	31,25 €	3	30
100	19,15 €	2,5	25	100	26,00 €	2,5	25	100	39,15 €	2	25
120	23,35 €	2	20	120	31,25 €	2	20	Max.660 °C. Rozmery:0,5 x 1m.			

Max.250 °C. Rozmery:0,5 x 1m.

Max.620 °C. Rozmery:0,5 x 1m.



## Pasívna protipožiarna ochrana stavieb

Potrubné systémy VZT a potrubia na odvod dymu a tepla

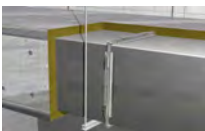

Orstech 65 H			
hr. (mm)	EUR/m2 bez DPH	m <sup>2</sup> / bal.	m <sup>2</sup> / pal.
40	14,85 €	6	60
60	19,80 €	4	40

Rozmery: 0,5 x 1m.

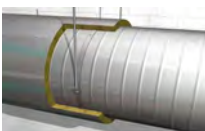

Orstech LSP PYRO			
hr. (mm)	EUR/m2 bez DPH	m <sup>2</sup> / bal.	m <sup>2</sup> / pal.
50	17,00 €	3	63

Šírka: 1m.



U PROTECT SLAB 4.0 Alu1 BLACK			
hr. (mm)	EUR/m2 bez DPH	m <sup>2</sup> / bal.	m <sup>2</sup> / pal.
30	27,10 €	9,36	112,32
40	34,50 €	7,2	86,4
60	49,85 €	4,32	51,84
80	64,00 €	3,6	43,2
100	79,00 €	2,88	34,56

Rozmery: 0,6 x 1,2m.

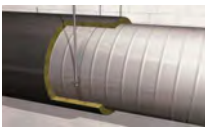

U PROTECT WIRED MAT 4.0 Alu1 BLACK			
hr. (mm)	EUR/m2 bez DPH	m <sup>2</sup> / bal.	m <sup>2</sup> / pal.
30	41,95 €	12	216
40	51,75 €	9	162
60	68,50 €	6	108
80	85,05 €	4,44	79,9
100	101,80 €	3,6	64,8
120	118,85 €	3	54

Šírka: 2x 0,6m

**Príslušenstvo (U PROTECT):**

**ISOVER PROTECT BSK (Iepidlo)**  
na riešenie upchávky v mieste prechodu VZT potrubia. Spotreba 0,3-1,5kg/m<sup>2</sup>.

kg / bal.	EUR/kg bez DPH	EUR/bal. bez DPH
8	11,25 €	90,00 €
15	12,20 €	183,00 €

**ISOVER PROTECT BSF (tmel)**  
Tmel určený na riešenie upchávky v mieste prechodu VZT potrubia.

kg / bal.	EUR/kg bez DPH	EUR/bal. bez DPH
15	38,00 €	570,00 €

**PROTECT BLACK TAPE**  
Páska šírka 90 mm x 100m

ks / bal.	EUR/m bez DPH	EUR/ks bez DPH
24	1,60 €	160,00 €



**FIRE PROTECT SCREW**

Špeciálne v ruty na v zájomné stiahnutie vrchnej izolačnej dosky. Spotreba cca 6ks/bm potrubia (len na hornú hranu izolácie). Dĺžka v ruty by mala byť min. 2-násobok hrúbky použitej izolácie.

Dĺžka (mm)	ks / bal.	EUR/ks bez DPH	EUR/bal. bez DPH
60	1000	0,250 €	250 €
80	1000	0,275 €	275 €
100	500	0,325 €	163 €
120	500	0,370 €	185 €
140	500	0,415 €	208 €
160	200	0,465 €	93 €
180	200	0,525 €	105 €
200	200	0,655 €	131 €

**ORSTECH PYRO - systém protipožiarnej ochrany VZT EI 30, 45, 60 min.**

Protipožiarne pasívne ochrany vzduchotechnického potrubia určené na dosiahnutie požiarnej odolnosti 30, 45 a 60 min. (EI 30 S, 45 S, 60 S) pre zvislú aj vodorovnú orientáciu potrubia pri pôsobení ohňa z vonka potrubia. Izolácia sa k potrubiu prichytáva prostredníctvom navarovacích trňov (spotreba cca 16ks/m<sup>2</sup>).

Hranaté potrubie (ORSTECH 65H):	Potrubie	EI 30 S	EI 45 S	EI 60 S
Požiar z vonka	↔ ↓	40 mm	40 mm	60 mm

Kruhové potrubie (ORSTECH LSP PYRO):	Potrubie	EI 30 S	EI 45 S	EI 60 S
Požiar z vonka	↔ ↓	50 mm	50 mm	50 mm

**U PROTECT - systém protipožiarnej ochrany VZT EI 15, 30, 45, 60, 90, 120 min.**

Protipožiarne pasívne ochrany vzduchotechnického potrubia určené na dosiahnutie požiarnej odolnosti 15, 30, 60, 90 a 120 min. (EI 15S, 30S, 45S, 60S, 90S, 120S) pre zvislú aj vodorovnú orientáciu potrubia pri pôsobení ohňa z vonka aj z vnútra potrubia. Izolácia sa k potrubiu prichytáva prostredníctvom navarovacích trňov (spotreba cca 20ks/m<sup>2</sup>). Na ukotvenie vrchnej dosky sa použijú oceľové vrtvy typu PROTECT SCREW. Pre kotvenie tesniacej upchávky k stene potrubia je nutné použiť vysokoteplotné lepidlo PROTECT BSK a následne zatmeliť tmelom BSF.

Hranaté potrubie (SLAB 4.0 Alu1):	Potrubie	EI 15S	EI 30S	EI 45S	EI 60S	EI 90S	EI 120S
Požiar z vonka	↔ ↓	30 mm	30 mm	30 mm	30 mm	80 mm	100 mm
Požiar z vnútra / z vonka	↔ ↓	40 mm	60 mm	80 mm	80 mm	100 mm	100 mm

Kruhové potrubie (WIRED MAT 4.0 Alu1)	Potrubie	EI 15S	EI 30S	EI 45S	EI 60S	EI 90S	EI 120S
Požiar z vonka	↔ ↓	30 mm	30 mm	30 mm	60 mm	100 mm	100 mm
Požiar z vnútra / z vonka	↔ ↓	40 mm	60 mm	60 mm	80 mm	100 mm	120 mm

**U PROTECT - potrubie pre odvod dymu a tepla EI 30 S 1500 multi**

Hranaté potrubie (SLAB 4.0 Alu1):	Potrubie	-	EI 30S
Požiar z vonka	↔ ↓	-	80mm

# SYSTEM VZDUCHOVODOV CLIMAVER®

Ušetrite priestor, peniaze, čas a energiu



**ISOVER**  
SAINT-GOBAIN

## DOSKY CLIMAVER

CLIMAVER® je izolované samonosné vzduchotechnické potrubie zabezpečujúce distribúciu upravovaného vzduchu pre účely vykurovania, vetrania a klimatizácie. Zaizolovaný vzduchotechnický kanál sa z jedného kusu materiálu vyrobí priamo na stavbe. Špeciálna úprava spojov VZT kanálov zaisťuje konštantný tlak v sieti potrubí s minimálnymi stratami. Vďaka zvukovej pohltivosti panelov už vo väčšine prípadov nie sú potrebné dodatočné tlmivé hluku.

CLIMAVER								
hr. izol. (mm)	Obj. kód	Rozmer (mm)	ks/bal.	m <sup>2</sup> / bal.	m <sup>2</sup> / pal.	EUR/ks bez DPH	EUR/m <sup>2</sup> bez DPH	
25	Climaver PLUS R	KD 52296	3000 x 1190	7	24,99	299,88	132,09 €	37 €
25	Climaver NETO	KD 24424	3000 x 1190	7	24,99	299,88	142,80 €	40 €
25	Climaver A2 PLUS	KD 65229	3000 x 1190	6	21,42	299,88	167,79 €	47 €
25	Climaver A2 - NETO	KD 20300	3000 x 1190	6	21,42	299,88	171,36 €	48 €
40	Climaver APTA	KD 57316	3000 x 1210	5	18,15	199,65	181,50 €	50 €
40	Climaver A1 APTA	KD 69377	3000 x 1210	5	18,15	199,65	217,80 €	60 €
40	Climaver A2 APTA	KD 65228	3000 x 1210	5	18,15	199,65	199,65 €	55 €
25	Climaver A2 DECO - NEGRO (black)	KD 65237	3000 x 1190	7	24,99	149,94	214,20 €	60 €
25	Climaver A2 DECO - GRIS (Grey)	KD ...	3000 x 1190	7	24,99	149,94	214,20 €	60 €
25	Climaver A2 DECO - COLORS (*)	KD ...	3000 x 1190	7	24,99	149,94	217,77 €	61 €
40	Climaver STAR	KD 70757	3000 x 1210	1	3,63	65,34	399,30 €	110 €

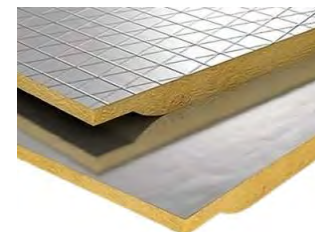

### Príslušenstvo:

Položka	Popis	MJ	EUR/MJ bez DPH
CLIMAVER set v kufríku so 4 reznými nástrojmi / Universal tools KD 10370	Jeden kufrík so 4 nástrojmi (3 Climaver MM s redukciami pre panely CLIMAVER hr. 25 mm a 40 mm + 1 univerzálny MTR)	bal	1 113 €
CLIMAVER set v kufríku so 5 reznými nástrojmi / Tools KD 25706	Jeden kufrík s 5 nástrojmi (3 Climaver MM pre panely CLIMAVER hr. 25 mm + 2 MTR)	bal	809 €
CLIMAVER set v kufríku so 3 reznými nástrojmi / MM Tools KD 14	Jeden kufrík s 3 nástrojmi (support + blades)	bal	668 €
CLIMAVER APTA Tools KD 57756	Jeden kufrík pre panely Climaver hr. 40 mm	bal	801 €
CLIMAVER nôž / Knives KD 35177	Balenie 15 nožov, cena za 1ks	ks	24 €
CLIMAVER univerzálny uholník / Universal angle guide KD 10371	Balenie s 1 uhelníkom	ks	908 €
CLIMAVER sponkovačka / Stapler KD 30297	1 zošívacia v balení	ks	206 €
CLIMAVER páska / Tape (50 m x 63 mm x 50 μ) KD 16373	Balenie 12 hliníkových pásiiek (50 m x 63 mm x 50 μ)	ks	49 €
CLIMAVER NETO páska / Tape (50m x 63mm x 50μ) KD 24988	Balenie 12 Neto pásiiek	ks	60 €
CLIMAVER DECO páska / Tape (55mx63mm) Black/Grey KD .....	(*) Množstvo pásky je regulované podľa nákupu m <sup>2</sup> CLIMAVER DECO	ks	144 €
CLIMAVER DECO páska / Tape (55mx63mm) Colors KD .....	(*) Množstvo pásky je regulované podľa nákupu m <sup>2</sup> CLIMAVER DECO	ks	144 €
CLIMAVER STAR páska / Tape (50 m x 75mm) KD 69617	Balenie obsahuje 10 ks hliníkových pásiiek STAR (50 m x 75 mm)	ks	239 €
CLIMAVER lepidlo / Glue (1 Liter/bottle) KD 20736	Balenie obsahuje 12 ks lepidla	ks	23 €
CLIMAVER STAR lepidlo / Glue (310 ml/) KD 69917	Balenie obsahuje 12 ks lepidla	ks	24 €
PERFIVER L KD 17200	Hliníkový profil, 1 balenie s 80 ks (1,155 m/ks)	m	6 €
PERFIVER H KD 14302	Hliníkový profil pre panely CLIMAVER hr. 25 mm, 1 balenie s 20 ks (2,0 m/ks)	m	13 €
PERFIVER H 40 KD 10246	Hliníkový profil pre panely CLIMAVER hr. 40 mm, 1 balenie s 20 ks, 2,0 m/ks	m	17 €
CLIMAVER náhradné čepele / Case blades replacement KD 1004	1 balenie s 10 krabičkami (1 krabička obsahuje 20 ks náhradných čepeľí)	bal	1 142 €
CLIMAVER APTA 40 /case blades replacement KD 64996	1 balenie s 10 krabičkami (1 krabička obsahuje 20 ks náhradných čepeľí)	bal	1 384 €
CLIMAVER sponky / Staples KD 30298	Balenie obsahuje 5.000 ks svorek	bal	29 €
CLIMAVER stierka / Spatulas KD 30821	1 balenie obsahuje 18 stierok	bal	40 €

## SKRUŽE s ALS fóliou "Combi"



**Paroc HVAC Combi AluCoat T** - Univerzálne vinuté puzdrá s ALS fóliou. Jedným typom skruže je možné zaizolovať väčší rozsah potrubí. Vnútorňý otvor hviezdicovitého prierezu umožňuje použiť jedno tepelnoizolačné puzdro na viac priemerov. Na strane ALS fólie nesmie teplota presiahnuť 80°C. Trieda reakcie na oheň A2-s1,d0.



**HVAC**

Vonk. Ø potr. (mm):	HVAC COMBI AluCoat T				HVAC COMBI AluCoat T				HVAC COMBI AluCoat T				HVAC COMBI AluCoat T			
	Hr. izolácie 20 mm				Hr. izolácie 30 mm				Hr. izolácie 40 mm				Hr. izolácie 50 mm			
	Obj, kód	bm/ bal.	bm/ pal.	EUR/bm bez DPH	Obj, kód	bm/ bal.	bm/ pal.	EUR/bm bez DPH	Obj, kód	bm/ bal.	bm/ pal.	EUR/bm bez DPH	Obj, kód	bm/ bal.	bm/ pal.	EUR/bm bez DPH
18	12/20 - 18/20	33,6	806,4	4,55 €	12/30 - 18/30	24	576	6,35 €	12/40 - 18/40	14,4	345,6	8,15 €	12/50 - 18/50	14,4	345,6	10,20 €
28	22/20 - 28/20	24	576	5,15 €	22/30 - 28/30	18	432	7,35 €	22/40 - 28/40	10,8	259,2	9,00 €	22/50 - 28/50	10,8	259,2	11,30 €
38	32/20 - 38/20	18	432	6,20 €	32/30 - 38/30	14,4	345,6	8,90 €	32/40 - 38/40	8,4	235,2	10,30 €	32/50 - 38/50	8,4	235,2	12,45 €
48	42/20 - 48/20	14,4	345,6	7,55 €	42/30 - 48/30	10,8	259,2	10,20 €	42/40 - 48/40	7,2	158,4	11,80 €	42/50 - 48/50	7,2	158,4	13,95 €

## SKRUŽE s ALS fóliou



**Paroc HVAC Section AluCoat T** - Vinuté izolačné puzdrá z minerálnej vlny s vystuženou AL fóliou a samolepiacim presahom. Dĺžka 1,2m. Max. prevádzková teplota 250°C, na strane ALS fólie nesmie teplota presiahnuť 80°C. Objemová hmotnosť 100kg/m<sup>3</sup>. Súčiniteľ tepelnej vodivosti λ10°C = 0,033 W/m.K. Trieda reakcie na oheň A2-s1,d0.



**HVAC**

Vonk. Ø potr. (mm):	HVAC Section AluCoat T				HVAC Section AluCoat T				HVAC Section AluCoat T				HVAC Section AluCoat T			
	Hr. izolácie 20 mm				Hr. izolácie 25 mm				Hr. izolácie 30 mm				Hr. izolácie 40 mm			
	Obj, kód	bm/ bal.	bm/ pal.	EUR/bm bez DPH	Obj, kód	bm/ bal.	bm/ pal.	EUR/bm bez DPH	Obj, kód	bm/ bal.	bm/ pal.	EUR/bm bez DPH	Obj, kód	bm/ bal.	bm/ pal.	EUR/bm bez DPH
15	15 / 20	42	1008	4,00 €	15 / 25	33,6	806,4	4,75 €	15 / 30	24	576	5,80 €	15 / 40	14,4	345,6	7,45 €
18	18 / 20	33,6	806,4	4,55 €	18 / 25	24	576	5,30 €	18 / 30	18	432	6,35 €	18 / 40	10,8	259,2	8,00 €
22	22 / 20	33,6	806,4	4,75 €	22 / 25	24	576	5,65 €	22 / 30	18	432	6,55 €	22 / 40	10,8	259,2	8,25 €
28	28 / 20	24	576	4,90 €	28 / 25	18	432	6,15 €	28 / 30	14,4	345,6	7,10 €	28 / 40	10,8	259,2	8,50 €
35	35 / 20	24	576	5,30 €	35 / 25	18	432	6,55 €	35 / 30	14,4	345,6	7,45 €	35 / 40	8,4	235,2	8,90 €
42	42 / 20	18	432	6,15 €	42 / 25	14,4	345,6	7,10 €	42 / 30	10,8	259,2	7,85 €	42 / 40	8,4	184,8	9,25 €
48	48 / 20	14,4	345,6	6,70 €	48 / 25	10,8	259,2	7,35 €	48 / 30	8,4	235,2	8,50 €	48 / 40	8,4	184,8	9,65 €
54	54 / 20	14,4	345,6	6,95 €	54 / 25	10,8	259,2	7,60 €	54 / 30	8,4	235,2	8,70 €	54 / 40	8,4	184,8	10,15 €
60	60 / 20	10,8	259,2	7,10 €	60 / 25	8,4	235,2	7,85 €	60 / 30	8,4	235,2	9,25 €	60 / 40	6	144	10,95 €
64	64 / 20	10,8	259,2	7,45 €	64 / 25	8,4	235,2	8,15 €	64 / 30	8,4	184,8	9,50 €	64 / 40	6	144	11,10 €
70	70 / 20	8,4	235,2	7,60 €	70 / 25	8,4	235,2	8,25 €	70 / 30	8,4	184,8	10,00 €	70 / 40	6	144	12,40 €
76	76 / 20	8,4	235,2	8,25 €	76 / 25	8,4	184,8	8,60 €	76 / 30	6	144	10,95 €	76 / 40	6	144	12,45 €
89	89 / 20	8,4	184,8	8,90 €	89 / 25	6	144	10,00 €	89 / 30	6	144	11,85 €	89 / 40	3,6	115,2	13,85 €
102					102 / 25	6	144	10,40 €	102 / 30	3,6	115,2	12,25 €	102 / 40	3,6	108	15,05 €
108					108 / 25	6	144	10,70 €	108 / 30	3,6	115,2	12,95 €	108 / 40	3,6	86,4	16,45 €
114					114 / 25	3,6	115,2	11,85 €	114 / 30	3,6	108	14,15 €	114 / 40	3,6	86,4	17,10 €
133					133 / 25	3,6	108	12,40 €	133 / 30	3,6	86,4	15,40 €	133 / 40	3,6	64,8	18,90 €
140					140 / 25	3,6	86,4	12,60 €	140 / 30	3,6	72	17,50 €	140 / 40	3,6	64,8	19,65 €
159					159 / 25	3,6	72	14,55 €	159 / 30	3,6	64,8	18,10 €	159 / 40	2,4	52,8	21,05 €
168					168 / 25	3,6	64,8	17,40 €	168 / 30	3,6	57,6	19,00 €	168 / 40	2,4	52,8	21,60 €
194											- €	194 / 40	2,4	43,2	25,30 €	
208									208 / 30	2,4	43,2	22,50 €	208 / 40	2,4	38,4	26,85 €
219									219 / 30	2,4	38,4	25,05 €	219 / 40	2,4	38,4	30,05 €



**Paroc HVAC Section AluCoat T** - Vinuté izolačné puzdrá z minerálnej vlny s vystuženou AL fóliou a samolepiacim presahom. Dĺžka 1,2m. Max. prevádzková teplota 250°C, na strane ALS fólie nesmie teplota presiahnuť 80°C. Objemová hmotnosť 100kg/m<sup>3</sup>. Súčiniteľ tepelnej vodivosti λ10°C = 0,034 W/m.K.



**HVAC**

Vonk. Ø potr. (mm):	HVAC Section AluCoat T				HVAC Section AluCoat T				HVAC Section AluCoat T				HVAC Section AluCoat T			
	Hr. izolácie 50 mm				Hr. izolácie 60 mm				Hr. izolácie 70 mm				Hr. izolácie 80 mm			
	Obj. kód	bm/ bal.	bm/ pal.	EUR/bm bez DPH	Obj. kód	bm/ bal.	bm/ pal.	EUR/bm bez DPH	Obj. kód	bm/ bal.	bm/ pal.	EUR/bm bez DPH	Obj. kód	bm/ bal.	bm/ pal.	EUR/bm bez DPH
18	18 / 50	8,4	235,2	9,90 €	18 / 60	6	144	11,45 €								
22	22 / 50	8,4	184,8	10,55 €	22 / 60	6	144	11,85 €	22 / 70	3,6	108	14,55 €	22 / 80	3,6	72	16,20 €
28	28 / 50	8,4	184,8	11,20 €	28 / 60	6	144	11,95 €	28 / 70	3,6	108	15,80 €	28 / 80	3,6	64,8	19,00 €
35	35 / 50	6	144	11,55 €	35 / 60	6	144	13,15 €	35 / 70	3,6	108	17,10 €	35 / 80	3,6	64,8	21,05 €
42	42 / 50	6	144	12,10 €	42 / 60	3,6	115,2	14,15 €	42 / 70	3,6	108	18,40 €	42 / 80	3,6	64,8	21,60 €
48	48 / 50	6	144	12,85 €	48 / 60	3,6	115,2	14,90 €	48 / 70	3,6	86,4	19,30 €	48 / 80	3,6	72	22,35 €
54	54 / 50	6	144	13,15 €	54 / 60	3,6	108	16,20 €	54 / 70	3,6	86,4	20,85 €	54 / 80	3,6	64,8	23,25 €
60	60 / 50	6	144	13,65 €	60 / 60	3,6	108	17,40 €	60 / 70	3,6	72	21,35 €	60 / 80	3,6	64,8	23,80 €
64	64 / 50	3,6	115,2	14,00 €	64 / 60	3,6	108	17,75 €	64 / 70	3,6	72	21,95 €	64 / 80	3,6	64,8	24,15 €
70	70 / 50	3,6	115,2	14,80 €	70 / 60	3,6	86,4	18,50 €	70 / 70	3,6	72	22,50 €	70 / 80	3,6	57,6	24,95 €
76	76 / 50	3,6	108	16,10 €	76 / 60	3,6	86,4	19,00 €	76 / 70	3,6	64,8	23,15 €	76 / 80	3,6	57,6	27,75 €
89	89 / 50	3,6	86,4	17,40 €	89 / 60	3,6	72	21,45 €	89 / 70	3,6	57,6	25,80 €	89 / 80	2,4	52,8	28,95 €
102	102 / 50	3,6	72	17,50 €	102 / 60	3,6	64,8	21,95 €	102 / 70	2,4	52,8	27,35 €	102 / 80	2,4	48	30,55 €
108	108 / 50	3,6	72	17,75 €	108 / 60	3,6	57,6	23,50 €	108 / 70	2,4	52,8	29,95 €	108 / 80	2,4	43,2	32,00 €
114	114 / 50	3,6	64,8	19,15 €	114 / 60	3,6	57,6	24,80 €	114 / 70	2,4	48	31,35 €	114 / 80	2,4	43,2	35,20 €
133	133 / 50	3,6	57,6	20,85 €	133 / 60	2,4	48	27,10 €	133 / 70	2,4	43,2	32,90 €	133 / 80	2,4	38,4	37,15 €
140	140 / 50	2,4	52,8	24,95 €	140 / 60	2,4	48	29,15 €	140 / 70	2,4	38,4	33,40 €	140 / 80	2,4	38,4	38,50 €
159	159 / 50	2,4	48	27,65 €	159 / 60	2,4	38,4	30,95 €	159 / 70	2,4	38,4	35,70 €	159 / 80	1,2	31,2	42,10 €
168	168 / 50	2,4	43,2	28,55 €	168 / 60	2,4	38,4	32,00 €	168 / 70	1,2	38,4	36,45 €	168 / 80	1,2	31,2	43,05 €
194	194 / 50	2,4	38,4	31,70 €	194 / 60	1,2	38,4	33,50 €	194 / 70	1,2	28,8	41,20 €	194 / 80	1,2	24	47,65 €
208	208 / 50	1,2	38,4	32,80 €	208 / 60	1,2	31,2	34,80 €	208 / 70	1,2	24	48,95 €	208 / 80	1,2	21,6	51,00 €
219	219 / 50	1,2	31,2	35,95 €	219 / 60	1,2	28,8	40,60 €	219 / 70	1,2	21,6	53,30 €	219 / 80	1,2	21,6	56,10 €
259	259 / 50	1,2	21,6	40,60 €	259 / 60	1,2	21,6	42,10 €	259 / 70	1,2	21,6	55,60 €	259 / 80	1,2	19,2	59,05 €
273	273 / 50	1,2	21,6	42,10 €	273 / 60	1,2	21,6	53,15 €	273 / 70	1,2	19,2	60,85 €	273 / 80	1,2	19,2	66,70 €
324				- €	324 / 60	1,2	36	- €	324 / 70	1,2	28,8	- €	324 / 80	1,2	26,4	- €
356	356 / 50	1,2	33,6	- €	356 / 60	1,2	26,4	- €	356 / 70	1,2	24	- €	356 / 80	1,2	24	- €
371	371 / 50	1,2	28,8	- €	371 / 60	1,2	24	- €	371 / 70	1,2	24	- €	371 / 80	1,2	19,2	- €
406	406 / 50	1,2	24	- €	406 / 60	1,2	21,6	- €	406 / 70	1,2	19,2	- €	406 / 80	1,2	19,2	- €
426	426 / 50	1,2	21,6	- €	426 / 60	1,2	19,2	- €	426 / 70	1,2	19,2	- €	426 / 80	1,2	19,2	- €
457	457 / 50	1,2	19,2	- €	457 / 60	1,2	19,2	- €	457 / 70	1,2	19,2	- €	457 / 80	1,2	16,8	- €
479	479 / 50	1,2	19,2	- €	479 / 60	1,2	19,2	- €	479 / 70	1,2	16,8	- €	479 / 80	1,2	14,4	- €
508	508 / 50	1,2	19,2	- €	508 / 60	1,2	16,8	- €	508 / 70	1,2	14,4	- €	508 / 80	1,2	14,4	- €
533	533 / 50	1,2	14,4	- €	533 / 60	1,2	14,4	- €	533 / 70	1,2	14,4	- €	533 / 80	1,2	12	- €
558	558 / 50	1,2	14,4	- €	558 / 60	1,2	14,4	- €	558 / 70	1,2	12	- €	558 / 80	1,2	9,6	- €
612	612 / 50	1,2	9,6	- €	612 / 60	1,2	9,6	- €	612 / 70	1,2	9,6	- €	612 / 80	1,2	7,2	- €
630	630 / 50	1,2	9,6	- €	630 / 60	1,2	9,6	- €	630 / 70	1,2	7,2	- €	630 / 80	1,2	7,2	- €
714	714 / 50	1,2	7,2	- €	714 / 60	1,2	7,2	- €	714 / 70	1,2	7,2	- €	714 / 80	1,2	7,2	- €
813	813 / 50	1,2	4,8	- €	813 / 60	1,2	4,8	- €	813 / 70	1,2	4,8	- €	813 / 80	1,2	4,8	- €

# IZOLAČNÉ VÝROBKY PRE HVAC/TZB IZOLÁCIE



Systémy izolácií HVAC/TZB v novodobých stavbách plnia niekoľko funkcií. Používajú sa na potrubné rozvody teplej a studenej vody, kúrenia alebo pre vzduchotechnické a klimatizačné kanály. Systém musí byť zaizolovaný tak, aby sa zaistili dobré tepelnoizolačné vlastnosti a tam kde sa to vyžaduje mal aj akustickú izoláciu. Ďalšou kľúčovou úlohou je zabrániť vzniku kondenzácie vzdušnej vlhkosti, ktorá spôsobuje koróziu materiálov, farebné škvrny a znižuje účinnosť tepelnej izolácie.



**PAROC®**





**Paroc HVAC Section AluCoat T** - Vinuté izolačné puzdrá z minerálnej vlny s vystuženou AL fóliou a samolepiacim presahom. Dĺžka 1,2m. Max. prevádzková teplota 250°C, na strane ALS fólie nesmie teplota presiahnuť 80°C. Objemová hmotnosť 100kg/m<sup>3</sup>. Súčiniteľ tepelnej vodivosti λ<sub>10°C</sub> = 0,034 W/m.K.



**HVAC**

Vonk. Ø potr. (mm):	HVAC Section AluCoat T				HVAC Section AluCoat T				HVAC Section AluCoat T				HVAC Section AluCoat T			
	Hr. izolácie 90 mm				Hr. izolácie 100 mm				Hr. izolácie 110 mm				Hr. izolácie 120 mm			
	Obj. kód	bm/ bal.	bm/ pal.	EUR/bm bez DPH	Obj. kód	bm/ bal.	bm/ pal.	EUR/bm bez DPH	Obj. kód	bm/ bal.	bm/ pal.	EUR/bm bez DPH	Obj. kód	bm/ bal.	bm/ pal.	EUR/bm bez DPH
35	35 / 90	3,6	64,8	22,15 €	35 / 100	3,6	57,6	25,30 €								
42	42 / 90	3,6	64,8	22,75 €												
48	48 / 90	3,6	57,6	25,05 €												
54	54 / 90	3,6	57,6	24,95 €	54 / 100	2,4	48	31,10 €								
60	60 / 90	2,4	52,8	27,10 €	60 / 100	2,4	48	32,00 €								
64	64 / 90	2,4	52,8	27,90 €	64 / 100	2,4	48	33,25 €	64 / 110	2,4	38,4	38,65 €	64 / 120	2,4	76,8	41,90 €
70	70 / 90	2,4	52,8	28,85 €	70 / 100	2,4	43,2	35,70 €	70 / 110	2,4	38,4	40,95 €	70 / 120	2,4	76,8	43,35 €
76	76 / 90	2,4	48	29,25 €	76 / 100	2,4	43,2	36,35 €	76 / 110	2,4	38,4	42,80 €	76 / 120	2,4	76,8	44,65 €
89	89 / 90	2,4	43,2	31,25 €	89 / 100	2,4	38,4	39,90 €	89 / 110	1,2	38,4	44,20 €	89 / 120	1,2	31,2	46,35 €
102	102 / 90	2,4	38,4	32,65 €	102 / 100	2,4	38,4	41,90 €	102 / 110	1,2	31,2	- €	102 / 120	1,2	28,8	- €
108	108 / 90	2,4	38,4	33,25 €	108 / 100	1,2	38,4	45,20 €	108 / 110	1,2	31,2	47,40 €	108 / 120	1,2	24	51,00 €
114	114 / 90	2,4	38,4	35,30 €	114 / 100	1,2	38,4	47,00 €	114 / 110	1,2	28,8	49,95 €	114 / 120	1,2	24	52,95 €
133	133 / 90	1,2	38,4	36,95 €	133 / 100	1,2	28,8	49,55 €	133 / 110	1,2	24	51,25 €	133 / 120	1,2	21,6	57,30 €
140	140 / 90	1,2	31,2	40,50 €	140 / 100	1,2	28,8	51,90 €	140 / 110	1,2	21,6	53,30 €	140 / 120	1,2	21,6	59,85 €
159	159 / 90	1,2	28,8	42,25 €	159 / 100	1,2	21,6	56,40 €	159 / 110	1,2	21,6	57,65 €	159 / 120	1,2	21,6	61,65 €
168	168 / 90	1,2	24	45,70 €	168 / 100	1,2	21,6	57,90 €	168 / 110	1,2	21,6	59,55 €	168 / 120	1,2	19,2	67,65 €
194	194 / 90	1,2	21,6	49,80 €	194 / 100	1,2	21,6	62,40 €	194 / 110	1,2	19,2	68,95 €				- €
208	208 / 90	1,2	21,6	51,65 €	208 / 100	1,2	19,2	65,60 €	208 / 110	1,2	19,2	72,65 €				- €
219	219 / 90	1,2	21,6	57,75 €	219 / 100	1,2	19,2	67,55 €	219 / 110	1,2	36	80,00 €	219 / 120	1,2	33,6	85,65 €
259	259 / 90	1,2	36	65,05 €	259 / 100	1,2	33,6	78,20 €	259 / 110	1,2	26,4	89,55 €	259 / 120	1,2	24	95,45 €
273	273 / 90	1,2	33,6	77,25 €	273 / 100	1,2	26,4	86,65 €	273 / 110	1,2	24	95,00 €	273 / 120	1,2	24	101,75 €
289	289 / 90	1,2	28,8	- €	289 / 100	1,2	24	- €	289 / 110	1,2	24	- €	289 / 120	1,2	21,6	- €
295	295 / 90	1,2	26,4	- €	295 / 100	1,2	24	- €	295 / 110	1,2	24	- €	295 / 120	1,2	21,6	- €
305	305 / 90	1,2	26,4	- €	305 / 100	1,2	24	- €	305 / 110	1,2	21,6	- €	305 / 120	1,2	19,2	- €
324	324 / 90	1,2	24	- €	324 / 100	1,2	24	- €	324 / 110	1,2	19,2	- €	324 / 120	1,2	19,2	- €
356	356 / 90	1,2	21,6	- €	356 / 100	1,2	19,2	- €	356 / 110	1,2	19,2	- €	356 / 120	1,2	19,2	- €
371	371 / 90	1,2	19,2	- €	371 / 100	1,2	19,2	- €	371 / 110	1,2	19,2	- €	371 / 120	1,2	19,2	- €
406	406 / 90	1,2	19,2	- €	406 / 100	1,2	19,2	- €	406 / 110	1,2	16,8	- €	406 / 120	1,2	14,4	- €
426	426 / 90	1,2	19,2	- €	426 / 100	1,2	16,8	- €	426 / 110	1,2	14,4	- €	426 / 120	1,2	14,4	- €
457	457 / 90	1,2	14,4	- €	457 / 100	1,2	14,4	- €	457 / 110	1,2	14,4	- €	457 / 120	1,2	12	- €
479	479 / 90	1,2	14,4	- €	479 / 100	1,2	14,4	- €	479 / 110	1,2	12	- €	479 / 120	1,2	9,6	- €
508	508 / 90	1,2	12	- €	508 / 100	1,2	9,6	- €	508 / 110	1,2	9,6	- €	508 / 120	1,2	9,6	- €
533	533 / 90	1,2	9,6	- €	533 / 100	1,2	9,6	- €	533 / 110	1,2	9,6	- €	533 / 120	1,2	7,2	- €
558	558 / 90	1,2	9,6	- €	558 / 100	1,2	9,6	- €	558 / 110	1,2	7,2	- €	558 / 120	1,2	7,2	- €
612	612 / 90	1,2	7,2	- €	612 / 100	1,2	7,2	- €	612 / 110	1,2	7,2	- €	612 / 120	1,2	7,2	- €
630	630 / 90	1,2	7,2	- €	630 / 100	1,2	7,2	- €	630 / 110	1,2	7,2	- €	630 / 120	1,2	7,2	- €
714	714 / 90	1,2	4,8	- €	714 / 100	1,2	4,8	- €	714 / 110	1,2	4,8	- €	714 / 120	1,2	4,8	- €
813	813 / 90	1,2	4,8	- €	813 / 100	1,2	4,8	- €	813 / 110	1,2	4,8	- €	813 / 120	1,2	4,8	- €

## LAMELOVÉ PÁSY HVAC s AL fóliou

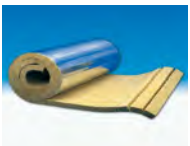

Lamelový izolačný pás z čadičovej vlny nalepený na hliníkovú fóliu s vystuženou sklotextilnou mriežkou.

PAROC HVAC Lamella Mat AluCoat (35kg/m3)			
hr. (mm)	EUR/m2 bez DPH	m <sup>2</sup> / bal.	m <sup>2</sup> / pal.
20	9,15 €	10	250
25	9,25 €	8	200
30	9,40 €	8	200
40	10,90 €	6	150
50	12,70 €	5	125
60	15,30 €	4	100
80	20,70 €	3	75
100	25,80 €	2,5	60

Max.250°C. Šírka 1m.

PAROC HVAC Lamella Mat AluCoat FIX			
hr. (mm)	EUR/m2 bez DPH	m <sup>2</sup> / bal.	m <sup>2</sup> / pal.
20	11,30 €	10	250
30	12,60 €	8	200
40	14,00 €	6	150
50	15,80 €	5	125
60	18,15 €	4	100
80	22,75 €	3	75
100	27,00 €	2,5	60

So samolepom. Šírka 1m.

## PÁSY HVAC s AL fóliou

Izolačný pás z pozdĺžnych vlákien nalepený na hliníkovú fóliu s vystuženou sklotextilnou mriežkou.

PAROC HVAC Mat AluCoat			
hr. (mm)	EUR/m2 bez DPH	m <sup>2</sup> / bal.	m <sup>2</sup> / pal.
30	7,10 €	8	168
40	8,10 €	7	147
50	9,35 €	7	147
60	15,55 €	7	147
80	17,90 €	5	105
100	20,75 €	4	84

Max.350°C. Šírka 1m.

## DOSKY HVAC



Izolačné dosky vyrobené z kamennej vlny sú určené k tepelnej a akustickej izolácií.

PAROC HVAC SLAB			
hr. (mm)	EUR/m2 bez DPH	m <sup>2</sup> / bal.	m <sup>2</sup> / pal.
50	15,60 €	5,76	69,12
100	28,25 €	3,6	36

Rozmery:0,6 x 1,2m. (alt.1,2x2m)

PAROC HVAC SLAB Alu			
hr. (mm)	EUR/m2 bez DPH	m <sup>2</sup> / bal.	m <sup>2</sup> / pal.
50	20,10 €	5,76	69,12
100	35,35 €	3,6	36

Rozmery:0,6 x 1,2m. (alt.1,2x2m)

## DOSKY HVAC s netkanou sklenou textíliou



N1- doska z jednej strany kaširovaná netkanou sklenou textíliou bielej farby.

N3- doska z jednej strany kaširovaná netkanou sklenou textíliou čiernej farby.

HVAC SLAB 60 N1			
hr. (mm)	EUR/m2 bez DPH	ks/ pal.	m <sup>2</sup> / pal.
50	17,20 €	48	115,2
100	31,45 €	24	57,6

Rozmery:2 x 1,2m.(alt. 0,6x1,2m)

InVent 60 N3			
hr. (mm)	EUR/m2 bez DPH	ks/ pal.	m <sup>2</sup> / pal.
50	15,40 €	24	57,6
100	25,75 €	12	28,8

Rozmery:2 x 1,2m.(alt. 0,6x1,2m)

InVent 80 N3 alebo N1			
hr. (mm)	EUR/m2 bez DPH	ks/ pal.	m <sup>2</sup> / pal.
15	11,25 €	80	192
30	12,90 €	40	96
50	18,50 €	24	57,6
100	35,15 €	12	28,8

Rozmery:2 x 1,2m.(alt. 0,6x1,2m)

## DOSKY HVAC s tkanou sklenou textíliou



G9 - doska z jednej strany kaširovaná antibakteriálnou tkanou sklenou textíliou čiernej farby.

InVent 40 G9			
hr. (mm)	EUR/m2 bez DPH	ks/ pal.	m <sup>2</sup> / pal.
-	-	-	-
50	23,65 €	24	57,6
100	44,65 €	12	28,8

Rozmery:2 x 1,2m.

InVent 60 G9			
hr. (mm)	EUR/m2 bez DPH	ks/ pal.	m <sup>2</sup> / pal.
30	12,90 €	40	96
50	26,10 €	24	57,6
100	49,55 €	12	28,8

Rozmery:2 x 1,2m.

InVent 80 G9			
hr. (mm)	EUR/m2 bez DPH	ks/ pal.	m <sup>2</sup> / pal.
30	14,25 €	40	96
50	28,70 €	24	57,6
100	55,50 €	12	28,8

Rozmery:2 x 1,2m.

## ROHOŽE PAROC PRO na drôtenom pletive

Izolačné rohože s pozinkovaným šesťhranným drôteným pletivom.



PRO



PAROC PRO Wired Mat 660 (80kg/m <sup>3</sup> )				PAROC PRO Wired Mat 660 AluCoat (80kg/m <sup>3</sup> )				PAROC PRO Wired Mat 680 (100kg/m <sup>3</sup> )				PAROC PRO Wired Mat 130 (130kg/m <sup>3</sup> )			
hr. (mm)	EUR/m <sup>2</sup> bez DPH	m <sup>2</sup> / bal.	m <sup>2</sup> / pal.	hr. (mm)	EUR/m <sup>2</sup> bez DPH	m <sup>2</sup> / bal.	m <sup>2</sup> / pal.	hr. (mm)	EUR/m <sup>2</sup> bez DPH	m <sup>2</sup> / bal.	m <sup>2</sup> / pal.	hr. (mm)	EUR/m <sup>2</sup> bez DPH	m <sup>2</sup> / bal.	m <sup>2</sup> / pal.
30	12,65 €	8	168	30	21,35 €	8	168	30	14,05 €	8	168	50	25,65 €	4,5	94,5
40	16,90 €	6,5	136,5	40	22,25 €	6,5	136,5	40	19,40 €	6,5	136,5	60	31,75 €	4	84
50	19,70 €	5	105	50	26,60 €	5	105	50	23,80 €	4,5	94,5	80	46,30 €	3	63
60	22,00 €	4	84	60	28,75 €	4	84	60	27,90 €	4	84	100	51,40 €	2	42
70	26,60 €	3,5	73,5	80	35,80 €	3,5	73,5	70	33,85 €	3,5	73,5	Max.680°C. Šírka 1m.			
80	29,05 €	3,5	73,5	100	43,75 €	2,5	52,5	80	36,50 €	3,5	73,5				
90	32,55 €	3	63	120	52,35 €	2	42	100	40,05 €	2,5	52,5				
100	36,95 €	2,5	52,5	Max.660°C. Šírka 1m.				120	43,20 €	2	42	Max.680°C. Šírka 1m.			
120	38,95 €	2	42												

Max.660°C. Šírka 1m.

Max.680°C. Šírka 1m.

## PÁSY PAROC PRO MAT

Izolačné pásy s pozdĺžnym vláknom.



PAROC PRO Mat 50 (50kg/m <sup>3</sup> )				PAROC PRO Mat 50 AluCoat (50kg/m <sup>3</sup> )				PAROC PRO Mat 80 (80kg/m <sup>3</sup> )				PAROC PRO Mat 100 (100kg/m <sup>3</sup> )			
hr. (mm)	EUR/m <sup>2</sup> bez DPH	m <sup>2</sup> / bal.	m <sup>2</sup> / pal.	hr. (mm)	EUR/m <sup>2</sup> bez DPH	m <sup>2</sup> / bal.	m <sup>2</sup> / pal.	hr. (mm)	EUR/m <sup>2</sup> bez DPH	m <sup>2</sup> / bal.	m <sup>2</sup> / pal.	hr. (mm)	EUR/m <sup>2</sup> bez DPH	m <sup>2</sup> / bal.	m <sup>2</sup> / pal.
40	8,55 €	7	147	40	9,60 €	7	147	40	10,80 €	6,5	136,5	40	14,85 €	6,5	136,5
50	9,05 €	6,5	136,5	50	11,00 €	6,5	136,5	50	11,30 €	5	105	50	15,10 €	4,5	94,5
80	15,65 €	5	105	60	13,50 €	6	126	60	13,65 €	4	84	60	17,45 €	4	84
100	20,05 €	4	84	100	21,90 €	4	84	80	18,35 €	3	63	100	28,75 €	2	42
Max.350°C. Šírka 1m.				Max.350°C. Šírka 1m.				Max.550°C. Šírka 1m.				Max.550°C. Šírka 1m.			

Max.350°C. Šírka 1m.

Max.350°C. Šírka 1m.

Max.550°C. Šírka 1m.

Max.550°C. Šírka 1m.

## PÁSY PAROC PRO LAMELLA MAT

Lamelové pásy s AL fóliou.



PAROC PRO Lamella Mat AluCoat (50kg/m <sup>3</sup> )			
hr. (mm)	EUR/m <sup>2</sup> bez DPH	m <sup>2</sup> / bal.	m <sup>2</sup> / pal.
20	11,75 €	10	250
30	12,65 €	8	200
40	15,75 €	6	150
50	17,95 €	5	125
60	19,65 €	4	100
80	29,40 €	3	75
100	36,15 €	2,5	62,5
Max.500°C. Šírka 1m.			

Max.500°C. Šírka 1m.

# ROCKWOOL 800

Potrúbné puzdro z nehorľavej kamennej vlny pre izoláciu rozvodov tepla a teplej vody, centrálného vykurovania a ďalších zariadení



ÚSPORY TEPLA PRI POUŽITÍ POTRUBNÉHO PUZDRA ROCKWOOL 800								
vnútorný priemer potrubného puzdra [mm]	hrúbka izolačnej vrstvy [mm]							
	20	30	40	50	60	70	80	100
15	75 %	79 %						
18	77 %	80 %						
22	78 %	81 %	84 %					
28	79 %	83 %	85 %	86 %				
35	80 %	84 %	86 %	87 %				
42	81 %	84 %	86 %	88 %	89 %			
48	81 %	85 %	87 %	88 %	89 %			
54	81 %	85 %	87 %	89 %	90 %			
60	82 %	85 %	88 %	89 %	90 %			
64	82 %	86 %	88 %	89 %	90 %			
70		86 %	88 %	89 %	90 %	91 %		
76		86 %	88 %	89 %	90 %	91 %		
89		86 %	88 %	90 %	91 %	92 %	92 %	
108		86 %	89 %	90 %	91 %	92 %	93 %	93 %
114		87 %	89 %	90 %	91 %	92 %	93 %	93 %
133		87 %	89 %	90 %	91 %	92 %	93 %	94 %
140		87 %	89 %	90 %	91 %	92 %	93 %	94 %
159				91 %	92 %	92 %	93 %	94 %
169				91 %	92 %	92 %	93 %	94 %

Výpočty boli vykonané pre teplotu média 55 °C a teplotu okolia 18 °C.

Úspora je rozdiel medzi neizolovaným potrubím a potrubím zaizolovaným pomocou puzdiel ROCKWOOL 800.



[www.rockwool.sk](http://www.rockwool.sk)



**ROCKWOOL 800** je nehorľavé puzdro z kamennej vlny s nalepenou hliníkovou fóliou vystuženou sklenenou mriežkou.

Puzdro má na pozdĺžnom spoji presah fólie so samolepiacou páskou. Dĺžka 1m. Max. prevádzková teplota 250°C. Objemová hmotnosť 100kg/m3. Súčiniteľ tepelnej vodivosti  $\lambda_{10^\circ\text{C}} = 0,033 \text{ W/m.K}$ . Trieda reakcie na oheň A2-s1,d0.

Vonk. Ø potr. (mm):	Rockwool 800				Rockwool 800				Rockwool 800				Rockwool 800			
	Hr. izolácie 20 mm				Hr. izolácie 30 mm				Hr. izolácie 40 mm				Hr. izolácie 50 mm			
	Obj. kód	bm/ bal.	bm/ pal.	EUR/bm bez DPH	Obj. kód	bm/ bal.	bm/ pal.	EUR/bm bez DPH	Obj. kód	bm/ bal.	bm/ pal.	EUR/bm bez DPH	Obj. kód	bm/ bal.	bm/ pal.	EUR/bm bez DPH
15	15 / 20	48	576	3,50 €	15 / 30	25	300	4,00 €	15 / 40	16	144	5,70 €				
18	18 / 20	42	504	3,80 €	18 / 30	25	300	4,30 €	18 / 40	12	108	6,00 €				
22	22 / 20	36	432	4,00 €	22 / 30	20	240	4,90 €	22 / 40	13	156	6,30 €	22 / 50	9	81	13,20 €
28	28 / 20	30	360	4,30 €	28 / 30	20	240	5,20 €	28 / 40	12	144	6,30 €	28 / 50	9	81	13,70 €
35	35 / 20	25	300	4,60 €	35 / 30	16	192	5,50 €	35 / 40	9	108	6,90 €	35 / 50	7	84	11,40 €
42	42 / 20	20	240	4,90 €	42 / 30	12	144	5,70 €	42 / 40	9	108	7,20 €	42 / 50	6	72	12,00 €
48	48 / 20	16	192	4,90 €	48 / 30	12	144	6,00 €	48 / 40	9	108	7,50 €	48 / 50	6	72	12,60 €
54	54 / 20	16	192	5,20 €	54 / 30	10	120	6,30 €	54 / 40	8	96	8,00 €	54 / 50	5	60	12,90 €
60	60 / 20	12	144	6,90 €	60 / 30	9	108	8,00 €	60 / 40	6	72	10,60 €	60 / 50	5	60	14,00 €
64	64 / 20	12	144	7,50 €	64 / 30	9	108	8,90 €	64 / 40	6	72	11,40 €	64 / 50	4	48	16,00 €
70					70 / 30	8	96	11,20 €	70 / 40	5	60	14,00 €	70 / 50	4	48	20,30 €
76					76 / 30	7	84	11,70 €	76 / 40	5	60	14,30 €	76 / 50	4	48	21,40 €
89					89 / 30	6	72	12,90 €	89 / 40	4	48	16,00 €	89 / 50	-	33	23,40 €
108					108 / 30	4	48	14,30 €	108 / 40	-	33	18,60 €	108 / 50	-	27	24,60 €
114					114 / 30	4	48	15,70 €	114 / 40	-	32	19,10 €	114 / 50	-	25	27,10 €
133					133 / 30	-	32	16,90 €	133 / 40	-	25	21,40 €	133 / 50	-	24	29,40 €
140					140 / 30	-	30	18,30 €	140 / 40	-	24	23,10 €	140 / 50	-	20	31,40 €
159					159 / 30	-	25	20,90 €	159 / 40	-	20	23,70 €	159 / 50	-	16	34,00 €
168					168 / 30	-	22	22,80 €	168 / 40	-	19	28,30 €	168 / 50	-	16	35,10 €
Vonk. Ø potr. (mm):	Rockwool 800				Rockwool 800				Rockwool 800				Rockwool 800			
	Hr. izolácie 60 mm				Hr. izolácie 70 mm				Hr. izolácie 80 mm				Hr. izolácie 100 mm			
	Obj. kód	bm/ bal.	bm/ pal.	EUR/bm bez DPH	Obj. kód	bm/ bal.	bm/ pal.	EUR/bm bez DPH	Obj. kód	bm/ bal.	bm/ pal.	EUR/bm bez DPH	Obj. kód	bm/ bal.	bm/ pal.	EUR/bm bez DPH
60	60 / 60	4	48	23,10 €												
64	64 / 60	-	36	23,40 €	64 / 70	-	28	24,30 €								
70	70 / 60	-	33	24,00 €	70 / 70	-	26	27,70 €								
76	76 / 60	-	30	24,60 €	76 / 70	-	25	29,10 €	76 / 80	-	20	32,30 €				
89	89 / 60	-	27	26,60 €	89 / 70	-	22	30,80 €	89 / 80	-	19	34,80 €	89 / 100	-	12	53,60 €
108	108 / 60	-	23	29,10 €	108 / 70	-	19	34,00 €	108 / 80	-	16	38,80 €	108 / 100	-	11	55,60 €
114	114 / 60	-	20	30,80 €	114 / 70	-	17	36,80 €	114 / 80	-	15	42,80 €	114 / 100	-	11	59,00 €
133	133 / 60	-	17	33,70 €	133 / 70	-	15	43,10 €	133 / 80	-	12	52,50 €	133 / 100	-	10	67,30 €
140	140 / 60	-	16	34,20 €	140 / 70	-	14	43,40 €	140 / 80	-	12	52,80 €	140 / 100	-	9	69,00 €
159	159 / 60	-	14	38,80 €	159 / 70	-	12	47,90 €	159 / 80	-	11	57,60 €	159 / 100	-	8	69,30 €
168	168 / 60	-	12	39,70 €	168 / 70	-	11	48,80 €	168 / 80	-	10	57,90 €	168 / 100	-	8	70,20 €
194													194 / 100	-	6	78,70 €
219													219 / 100	-	6	94,70 €
273													273 / 100	-	5	110,10 €

## LAMELOVÉ PÁSY s ALS fóliou , samolepiace



KLIMAFIX			
hr. (mm)	EUR/m2 bez DPH	m <sup>2</sup> / bal.	m <sup>2</sup> / pal.
20	9,50 €	10	240
30	11,80 €	8	192
40	13,80 €	6	144
50	16,10 €	5	120

Max.50°C. Šírka 1m.

## LAMELOVÉ PÁSY s ALS fóliou

Lamelový izolačný pás z čadičovej vlny nalepený na hliníkovú fóliu vystuženú sklotextilnou mriežkou.



Larock 40 ALS			
hr. (mm)	EUR/m2 bez DPH	m <sup>2</sup> / bal.	m <sup>2</sup> / pal.
20	5,40 €	10	240
30	6,70 €	8	192
40	8,20 €	6	144
50	9,00 €	5	120
60	11,30 €	4	96
80	12,50 €	3	72
100	16,60 €	2,5	60

Max.250°C. Šírka 1m.

## DOSKY s hliníkovou fóliou "ALS"



Techrock 40 ALS				Techrock 60 ALS				Techrock 80 ALS			
hr. (mm)	EUR/m2 bez DPH	m <sup>2</sup> / bal.	m <sup>2</sup> / pal.	hr. (mm)	EUR/m2 bez DPH	m <sup>2</sup> / bal.	m <sup>2</sup> / pal.	hr. (mm)	EUR/m2 bez DPH	m <sup>2</sup> / bal.	m <sup>2</sup> / pal.
40	12,80 €	9	72	40	16,40 €	7,2	72	40	17,10 €	7,2	72
60	0,00 €	6	48	60	22,50 €	4,8	48	60	23,80 €	4,8	48
80	0,00 €	4,8	38,4	80	0,00 €	3,6	36	80	29,10 €	3,6	36

Max.250°C. Rozmery 0,6 x 1m.

Max.250°C. Rozmery 0,6 x 1m.

Max.250°C. Rozmery 0,6 x 1m.

## DOSKY s čiernou netkanou sklotextiliou "FB1"



Techrock 40 FB1				Techrock 60 FB1				Techrock 100 FB2			
hr. (mm)	EUR/m2 bez DPH	ks/ pal.	m <sup>2</sup> / pal.	hr. (mm)	EUR/m2 bez DPH	ks/ pal.	m <sup>2</sup> / pal.	hr. (mm)	EUR/m2 bez DPH	m <sup>2</sup> / bal.	m <sup>2</sup> / pal.
50	14,30 €	48	57,6	40	0,00 €	30	72	60	34,00 €	2,5	40
				50	18,70 €	24	57,6				
				60	0,00 €	20	48				
				80	0,00 €	15	36				
				100	32,70 €	12	28,8				

Max.400°C. Rozmery 1,2 x 1m.

Rozmery 1, x 0,5m.

Max.560°C. Rozmery 1,2 x 2m.

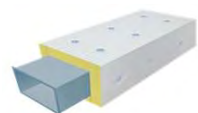

TECHROCK 60 ALS			
hr. (mm)	EUR/m2 bez DPH	m <sup>2</sup> / bal.	m <sup>2</sup> / pal.
40	16,40 €	7,2	72

TECHROCK 80 ALS			
hr. (mm)	EUR/m2 bez DPH	m <sup>2</sup> / bal.	m <sup>2</sup> / pal.
60	23,80 €	4,8	48

Rozmery 0,6x1m.

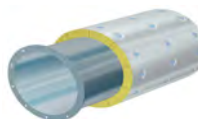

LAROCK 65 ALS			
hr. (mm)	EUR/m2 bez DPH	m <sup>2</sup> / bal.	m <sup>2</sup> / pal.
40	17,10 €	5	60

Šírka 1m.

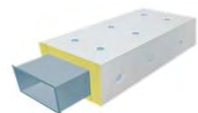

CONLIT DUCTROCK 60			
hr. (mm)	EUR/m2 bez DPH	m <sup>2</sup> / bal.	m <sup>2</sup> / pal.
60	76,30 €	-	30 (24)

Rozmery 1,5 x 1 m (alt. 1,2 x 1m)

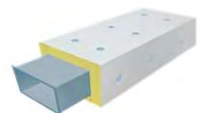

CONLIT DUCTROCK 90			
hr. (mm)	EUR/m2 bez DPH	m <sup>2</sup> / bal.	m <sup>2</sup> / pal.
60	89,00 €	-	30 (24)

Rozmery 1,5 x 1 m (alt. 1,2 x 1m)

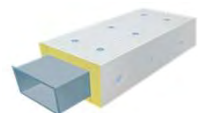

CONLIT DUCTROCK 120			
hr. (mm)	EUR/m2 bez DPH	m <sup>2</sup> / bal.	m <sup>2</sup> / pal.
60	101,70 €	-	30 (24)

Rozmery 1,5 x 1 m (alt. 1,2 x 1m)

### PYROROCK - systém protipožiarnej ochrany VZT 30, 45, 60 min.

HVAC

Systém požiarnej odolnosti hranatého VZT potrubia sa skladá z izolačných dosiek Techrock ALS pre požiarneho systému, navarovacích trňov pre ukotvenie izolácie a pásky ALS na prelepenie spojov. Systém zaisťuje požiarne odolnosť pre vodorovné zvislé potrubie: EI 30 a EI 45, prípadne EI 60.

Hranaté potrubie (TECHROCK ALS):	Potrubie	EI 30S	EI 45	EI 60
Požiar z vonka	↔ ↓	40 mm	40 mm	-
Požiar z vonka	↔ ↓	-	-	60 mm

### PYROROCK - systém protipožiarnej ochrany VZT EI 30, 45, 60 min.

Systém požiarnej odolnosti kruhového VZT potrubia sa skladá z izolačnej rohože Larock 65 ALS, navarovacích trňov s klobúčikmi pre ukotvenie izolácie a pásky ALS na prelepenie spojov. Pri priemere potrubia nad 500 mm je nutné ovinúť vodorovné potrubie šesťhranným pletivom s ukotvením na trne. Systém zaisťuje požiarne odolnosť pre vodorovné alebo zvislé potrubie EI 30 S a EI 45 S.

Kruhové potrubie (LAROCK 65ALS):	Potrubie	EI 30S	EI 45	EI 60 S
Požiar z vonka	↔ ↓	40 mm	40 mm	-

### CONLIT DUCTROCK - systém protipožiarnej ochrany VZT EI 60, 90, 120 min.

Systém ochrany pravouhlého vzduchotechnického potrubia proti požiaru z vonka aj z vnútra sa skladá z dosiek Conlit Ductrock 60, Conlit Ductrock 90 alebo Conlit Ductrock 120 a navarovacích trňov. Všetky spoje izolačných dosiek sa zaisťujú pomocou lepidla Conlit Fix a prelepujú ALS páskou.

Hranaté potrubie (CONLIT DUCTROCK):	Potrubie	EI 60 S	EI 90S	EI 120S
Požiar z vnútra / z vonka	↔ ↓	CD 60	CD 90	CD 120

### CONLIT DUCTROCK - systém pre odvod dymu a tepla EI 60 min.

Hranaté potrubie (CONLIT DUCTROCK):	Potrubie	EI 60 S 500 multi
Potrubie max.rozmerov 1,25 x 1m	↔ ↓	Ductrock 60

### Príslušenstvo k systémom CONLIT DUCTROCK:

Conlit FIX	kg / bal.	EUR/kg bez DPH	EUR/bal. bez DPH
Systémové lepidlo na spojovanie a lepenie dosiek CONLIT DUCTROCK. Spotreba 0,5 kg/m <sup>2</sup> izolácie pri nanosení 2mm.	20	8,20 €	164,00 €

# SYSTÉM NEHORĽAVEJ IZOLÁCIE ROZVODOV CHLADENIA - TECLIT



**TECLIT PS** je nehorľavé puzdro z kamennej vlny s pevnou hliníkovou fóliou a samolepiacim presahom, vhodné na izolovanie rozvodov chladenia a studenej vody v budovách. Systém chráni potrubie pred koróziou a vznikom kondenzácie. Dĺžka 1m. Prevádzková teplota od 0°C do 250°C, na strane ALS fólie 80°C. Faktor difúzneho odporu  $\mu > 10\ 000$ . Súčiniteľ tepelnej vodivosti  $\lambda_{10^\circ\text{C}} = 0,033\ \text{W/m.K}$ . Trieda reakcie na oheň A2-s1,d0.

**TECLIT HA** chladové izolačné závesy do systému TECLIT (dodávané bez kovovej objímky)



HVAC



Vonk. Ø potr.	Skrúž s AL TECLIT PS				Iz. záves TECLIT HA		
	Hr. izolácie 20 mm				Hr. izolácie 20 mm		
	Obj, kód	bm/ bal.	bm/ pal.	EUR/bm bez DPH	Obj, kód	ks/ bal.	EUR/ks bez DPH
15	15 / 20	48	576	6,25 €	15 / 20	25	13,10 €
18	18 / 20	42	504	6,95 €	18 / 20	25	13,40 €
22	22 / 20	36	432	7,60 €	22 / 20	25	13,65 €
28	28 / 20	30	360	8,10 €	28 / 20	25	13,95 €
35	35 / 20	25	300	8,70 €	35 / 20	25	14,75 €
42	42 / 20	20	240	9,15 €	42 / 20	25	15,30 €
48	48 / 20	16	192	9,60 €	48 / 20	25	15,85 €
	Hr. izolácie 30 mm				Hr. izolácie 30 mm		
22	22 / 30	20	240	9,15 €	22 / 30	25	15,30 €
28	28 / 30	20	240	9,75 €	28 / 30	25	15,85 €
35	35 / 30	16	192	10,35 €	35 / 30	25	16,10 €
42	42 / 30	12	144	11,15 €	42 / 30	25	16,95 €
48	48 / 30	12	144	11,80 €	48 / 30	25	17,75 €
54	54 / 30	10	120	12,25 €	54 / 30	25	17,75 €
60	60 / 30	9	108	12,75 €	60 / 30	25	18,60 €
64	64 / 30	-	108	14,25 €	64 / 30	25	19,65 €
70	70 / 30	-	96	15,00 €	70 / 30	25	20,75 €
76	76 / 30	-	84	15,70 €	76 / 30	25	21,60 €
89	89 / 30	-	72	16,90 €	89 / 30	25	21,85 €
	Hr. izolácie 40 mm				Hr. izolácie 40 mm		
35	35 / 40	9	108	13,00 €	35 / 40	25	18,30 €
42	42 / 40	9	108	13,55 €	42 / 40	25	19,40 €
48	48 / 40	9	108	14,30 €	48 / 40	25	19,40 €
54	54 / 40	8	96	14,95 €	54 / 40	10	19,95 €
60	60 / 40	6	72	16,50 €	60 / 40	10	20,75 €
64	64 / 40	-	72	18,35 €	64 / 40	10	22,95 €
70	70 / 40	-	60	18,80 €	70 / 40	10	23,20 €
76	76 / 40	-	60	19,25 €	76 / 40	10	23,50 €
89	89 / 40	-	48	21,15 €	89 / 40	10	25,40 €
108	108 / 40	-	33	24,95 €	108 / 40	10	28,95 €

Vonk. Ø potr. (mm):	Skrúž s AL TECLIT PS				Iz. záves TECLIT HA		
	Hr. izolácie 50 mm				Hr. izolácie 50 mm		
	Obj, kód	bm/ bal.	bm/ pal.	EUR/bm bez DPH	Obj, kód	ks/ bal.	EUR/ks bez DPH
48	48 / 50	6	72	20,85 €	48 / 50	25	22,65 €
54	54 / 50	5	60	21,35 €	54 / 50	10	23,20 €
89	89 / 50	-	33	31,10 €	89 / 50	10	27,60 €
108	108 / 50	-	27	32,65 €	108 / 50	10	29,75 €
114	114 / 50	-	25	36,30 €	114 / 50	10	32,50 €
133	133 / 50	-	24	39,30 €			- €
140	140 / 50	-	20	41,65 €	140 / 50	10	41,50 €
159	159 / 50	-	16	45,40 €	159 / 50	10	43,95 €
168	168 / 50	-	16	46,85 €	168 / 50	10	44,75 €
219	219 / 50	-	16	52,90 €	219 / 50	10	52,95 €
	Hr. izolácie 60 mm				Hr. izolácie 60 mm		
60	60 / 60	-	17	30,65 €	60 / 60	10	27,60 €
64	64 / 60	-	18	30,95 €	64 / 60	10	27,85 €
	Hr. izolácie 80 mm				Hr. izolácie 80 mm		
76	76 / 80	-	20	43,15 €	76 / 80	10	34,70 €
89	89 / 80	-	19	46,70 €	89 / 80	10	- €
108	108 / 80	-	16	51,70 €	108 / 80	10	- €
	Hr. izolácie 100 mm				Hr. izolácie 100 mm		
89	89 / 100	-	12	71,50 €	89 / 100	10	69,05 €
108	108 / 100	-	11	74,15 €	108 / 100	10	69,35 €
114	114 / 100	-	11	78,95 €	114 / 100	10	69,35 €
133	133 / 100	-	10	90,15 €			- €
140	140 / 100	-	9	92,05 €	140 / 100	10	73,70 €
159	159 / 100	-	8	92,50 €	159 / 100	10	84,90 €
168	168 / 100	-	8	93,90 €	168 / 100	10	85,70 €
219	219 / 100	-	6	126,15 €	219 / 100	10	209,30 €

## Príslušenstvo k systémom TECLIT:

Obj, kód	ks / bal.	EUR/ks bez DPH
Páska ALU TECLIT AT ( 50mm x 50m x 0,03mm)	24	22,64 €
Páska ALU TECLIT FT ( 50mm x 20m x 1,1mm )	20	115,77 €



## LAMELOVÉ PÁSY s ALS fóliou

Rockwool TECLIT LM			
hr. (mm)	EUR/m <sup>2</sup> bez DPH	m <sup>2</sup> / bal.	m <sup>2</sup> / pal.
30	13,30 €	8	96
40	16,40 €	6	72
50	18,40 €	5	60



# Technológia WR-Tech chráni technologické zariadenia pred vodou



Viac na [rti.rockwool.com](http://rti.rockwool.com)



## Ochrana proti korózií pod izoláciou

Izolácia z kamennej vlny ProRox s technológiou WR-Tech Water Repellency Technology bola prvá svojho druhu. Je najlepším riešením vo svojej triede, znižuje riziko vzniku korózie pod izoláciou a udržuje Vašu fabriku v suchu.

Teraz v rohožiach ProRox WM na drôtenom pletive.

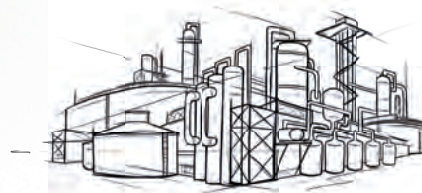

TECHNICAL INSULATION



**ROCKWOOL ProRox PS 960** je potrubná izolácia vyrábaná navíjaním na tvarovacie jadro.

Izolačné puzdra sa vyrábajú z kamennej vlny a za pomoci inovatívneho spojiva odpudzujúceho vodu WR-Tech kvôli znižovaniu rizika korózie pod izoláciou. Na požiadanie je k dispozícii obloženie z vystuženej hliníkovej fólie.

Dĺžka 1m. Max. prevádzková teplota 650°C. Objemová hmotnosť 100kg/m<sup>3</sup>.

Súčiniteľ tepelnej vodivosti λ50°C = 0,040 W/m.K. Trieda reakcie na oheň A1.

Vonk. Ø potr. (mm):	ProRox PS 960				ProRox PS 960				ProRox PS 960				ProRox PS 960			
	Hr. izolácie 25 mm				Hr. izolácie 30 mm				Hr. izolácie 40 mm				Hr. izolácie 50 mm			
	Obj, kód	bm/ bal.	bm/ pal.	EUR/bm bez DPH	Obj, kód	bm/ bal.	bm/ pal.	EUR/bm bez DPH	Obj, kód	bm/ bal.	bm/ pal.	EUR/bm bez DPH	Obj, kód	bm/ bal.	bm/ pal.	EUR/bm bez DPH
28	28 / 25	25	300	4,85 €	28 / 30	16	192	6,50 €	28 / 40	12	144	9,10 €	28 / 50	9	108	11,75 €
35	35 / 25	20	240	5,70 €	35 / 30	16	192	7,40 €	35 / 40	9	108	9,95 €	35 / 50	7	84	12,80 €
42	42 / 25	16	192	6,50 €	42 / 30	12	144	8,25 €	42 / 40	9	108	10,90 €	42 / 50	6	72	13,90 €
48	48 / 25	15	180	7,15 €	48 / 30	12	144	9,05 €	48 / 40	9	108	11,60 €	48 / 50	6	72	14,80 €
54	54 / 25	12	144	7,85 €	54 / 30	10	120	9,85 €	54 / 40	8	96	12,35 €	54 / 50	5	60	15,70 €
60	60 / 25	11	132	8,55 €	60 / 30	9	108	10,55 €	60 / 40	6	72	13,10 €	60 / 50	5	60	16,65 €
64	64 / 25	9	108	9,00 €	64 / 30	9	108	11,10 €	64 / 40	6	72	13,60 €	64 / 50	4	48	17,25 €
70	70 / 25	9	108	9,70 €	70 / 30	8	96	11,85 €	70 / 40	5	60	14,35 €	70 / 50	4	48	18,20 €
76	76 / 25	9	108	10,35 €	76 / 30	7	84	12,65 €	76 / 40	5	60	15,10 €	76 / 50	4	48	19,10 €
89	89 / 25	6	72	11,90 €	89 / 30	6	72	14,30 €	89 / 40	4	48	16,75 €	89 / 50	1	33	21,10 €
102	102 / 25	5	60	13,40 €	102 / 30	4	48	15,95 €	102 / 40	1	36	18,35 €	102 / 50	1	28	23,05 €
108	108 / 25	5	60	14,05 €	108 / 30	4	48	16,75 €	108 / 40	1	33	19,15 €	108 / 50	1	25	24,00 €
114	114 / 25	4	48	14,70 €	114 / 30	4	48	17,50 €	114 / 40	1	32	19,85 €	114 / 50	1	25	24,95 €
121	121 / 25	4		15,55 €	121 / 30	4	36	18,40 €	121 / 40	1	30	20,75 €	121 / 50	1	24	26,00 €
127	127 / 25	4	48	16,30 €	127 / 30	1	33	19,20 €	127 / 40	1	27	21,55 €	127 / 50	1	23	26,95 €
133	133 / 25	1	36	16,45 €	133 / 30	1	32	19,95 €	133 / 40	1	25	22,20 €	133 / 50	1	24	27,80 €
140	140 / 25	1	33	17,75 €	140 / 30	1	30	20,85 €	140 / 40	1	24	23,10 €	140 / 50	1	20	28,90 €
159	159 / 25	1	27	19,95 €	159 / 30	1	25	23,30 €	159 / 40	1	20	25,50 €	159 / 50	1	16	31,80 €
169	169 / 25	1	25	21,10 €	169 / 30	1	22	24,55 €	169 / 40	1	19	26,75 €	169 / 50	1	16	33,40 €
194	194 / 25	1	19	24,00 €	194 / 30	1	17	27,75 €	194 / 40	1	14	29,85 €	194 / 50	1	12	37,20 €
219	219 / 25	1	16	26,85 €	219 / 30	1	14	30,95 €	219 / 40	1	12	33,00 €	219 / 50	1	11	41,05 €
245	245 / 25	1		29,80 €	245 / 30	1		34,30 €	245 / 40	1	11	36,25 €	245 / 50	1	9	45,00 €
273	273 / 25	1		33,05 €	273 / 30	1	10	37,85 €	273 / 40	1	9	39,75 €	273 / 50	1	8	49,30 €
305	305 / 25	1		36,75 €	305 / 30	1	8	41,95 €	305 / 40	1	6	43,75 €	305 / 50	1	6	54,20 €
324	324 / 25	1		38,90 €	324 / 30	1	6	44,40 €	324 / 40	1	6	46,10 €	324 / 50	1	5	57,15 €
356					356 / 30	1	6	48,50 €	356 / 40	1	6	50,15 €	356 / 50	1	5	62,05 €
406					406 / 30			54,45 €	406 / 40	1	4	56,40 €	406 / 50	1	4	69,70 €
456					456 / 30			60,35 €	456 / 40	1		62,60 €	456 / 50	1		77,35 €
508									508 / 40	1		69,80 €	508 / 50	1		85,35 €
558													558 / 50	1		93,00 €
610													610 / 50	1		101,00 €
660													660 / 50	1		108,65 €
712													712 / 50	1		116,65 €
813													813 / 50	1		132,10 €
915													915 / 50	1		147,75 €



Vonk. Ø potr. (mm):	ProRox PS 960				ProRox PS 960				ProRox PS 960				ProRox PS 960			
	Hr. izolácie 60 mm				Hr. izolácie 80 mm				Hr. izolácie 100 mm				Hr. izolácie 120 mm			
	Obj. kód	bm/ bal.	bm/ pal.	EUR/bm bez DPH	Obj. kód	bm/ bal.	bm/ pal.	EUR/bm bez DPH	Obj. kód	bm/ bal.	bm/ pal.	EUR/bm bez DPH	Obj. kód	bm/ bal.	bm/ pal.	EUR/bm bez DPH
28	28 / 60	6	72	18,20 €	28 / 80	1	33	31,10 €								
35	35 / 60	5	60	19,40 €	35 / 80	1	30	32,60 €								
42	42 / 60	4	48	20,65 €	42 / 80	1	28	34,05 €								
48	48 / 60	4	48	21,70 €	48 / 80	1	27	35,35 €								
54	54 / 60	4	48	22,75 €	54 / 80			36,05 €								
60	60 / 60	4	48	23,75 €	60 / 80	1	24	37,95 €	60 / 100	1	16	48,35 €	60 / 120	1		58,05 €
64	64 / 60	1	36	24,45 €	64 / 80	1	24	38,80 €	64 / 100	1		49,45 €	64 / 120			59,50 €
70	70 / 60	1	33	25,50 €	70 / 80	1	24	40,05 €	70 / 100	1		51,15 €	70 / 120			61,90 €
76	76 / 60	1	30	26,55 €	76 / 80	1	20	41,35 €	76 / 100	1	14	52,80 €	76 / 120	1		62,95 €
89	89 / 60	1	27	28,80 €	89 / 80	1	19	44,10 €	89 / 100	1	12	56,35 €	89 / 120	1	10	66,90 €
102	102 / 60	1	24	31,10 €	102 / 80	1	16	46,90 €	102 / 100	1	12	59,95 €	102 / 120			70,65 €
108	108 / 60	1	23	32,10 €	108 / 80	1	16	48,20 €	108 / 100	1	11	61,60 €	108 / 120			72,90 €
114	114 / 60	1	20	33,15 €	114 / 80	1	15	49,45 €	114 / 100	1	11	63,25 €	114 / 120	1	8	74,50 €
121	121 / 60	1	20	34,35 €	121 / 80	1	14	51,00 €	121 / 100	1	11	65,10 €	121 / 120			76,50 €
127	127 / 60	1	19	35,40 €	127 / 80	1	12	52,30 €	127 / 100	1	10	66,80 €	127 / 120			78,50 €
133	133 / 60	1	17	36,40 €	133 / 80	1	12	53,55 €	133 / 100	1	10	68,45 €	133 / 120	1		80,50 €
140	140 / 60	1	16	37,65 €	140 / 80	1	12	55,05 €	140 / 100	1	9	70,35 €	140 / 120	1	8	82,45 €
159	159 / 60	1	14	40,95 €	159 / 80	1	11	59,10 €	159 / 100	1	8	75,65 €	159 / 120	1		88,25 €
169	169 / 60	1	12	42,70 €	169 / 80	1	10	61,25 €	169 / 100	1	8	78,35 €	169 / 120	1	6	91,25 €
194	194 / 60	1	11	47,05 €	194 / 80	1	8	66,60 €	194 / 100	1	6	85,25 €	194 / 120	1		98,90 €
219	219 / 60	1	9	51,40 €	219 / 80	1	8	71,95 €	219 / 100	1	6	92,10 €	219 / 120	1	5	106,55 €
245	245 / 60	1	8	55,90 €	245 / 80	1	6	77,55 €	245 / 100	1	5	99,30 €	245 / 120	1		114,45 €
273	273 / 60	1	6	60,80 €	273 / 80	1	5	83,50 €	273 / 100	1	5	107,00 €	273 / 120	1	4	123,00 €
305	305 / 60	1	5	66,30 €	305 / 80	1	5	90,35 €	305 / 100	1	4	115,80 €	305 / 120	1		130,80 €
324	324 / 60	1	5	69,60 €	324 / 80	1	4	94,45 €	324 / 100	1		121,00 €	324 / 120	1		138,60 €
356	356 / 60	1	4	75,15 €	356 / 80	1	4	101,30 €	356 / 100	1		129,85 €	356 / 120	1		148,35 €
406	406 / 60	1		83,90 €	406 / 80	1		112,00 €	406 / 100	1		143,60 €	406 / 120	1		163,60 €
456	456 / 60	1		92,50 €	456 / 80	1		122,70 €	456 / 100	1		157,35 €	456 / 120			176,20 €
508	508 / 60	1		101,60 €	508 / 80	1		133,80 €	508 / 100	1		171,65 €	508 / 120			197,35 €
558	558 / 60	1		110,25 €	558 / 80	1		144,55 €	558 / 100	1		185,40 €	558 / 120			213,20 €
610	610 / 60	1		119,30 €	610 / 80	1		155,65 €	610 / 100	1		199,75 €	610 / 120			223,70 €
660	660 / 60	1		127,95 €	660 / 80	1		166,35 €	660 / 100	1		213,45 €	660 / 120			239,05 €
712	712 / 60	1		137,00 €	712 / 80	1		177,50 €	712 / 100	1		227,75 €				
813	813 / 60	1		154,55 €	813 / 80	1		199,10 €	813 / 100	1		255,60 €				

## LAMELOVÉ PÁSY s ALS fóliou

Lamelový izolačný pás z čadičovej vlny nalepený na hliníkovú fóliu vystuženú sklotextilnou mriežkou.



<b>ProRox LM 930 ALU</b> (Larock 55 ALS)			
hr. (mm)	EUR/m2 bez DPH	m <sup>2</sup> / bal.	m <sup>2</sup> / pal.
30	11,70 €	8	192
40	14,55 €	6	144
50	18,10 €	4	96
60	20,65 €	3	72
80	26,25 €	2,5	60
100	31,20 €	2	48

Max.550°C. Šírka 1m.



<b>ProRox MA 520 ALU</b> (60kg/m3)			
hr. (mm)	EUR/m2 bez DPH	m <sup>2</sup> / bal.	m <sup>2</sup> / pal.
50	32,20 €	5	-
60	35,50 €	4,5	-
80	40,85 €	3,5	-
100	47,00 €	3	-

Max.500°C. Šírka 0,5m.

## ROHOŽE na drôtenom pletive "WM"

Izolačné rohože z kamennej vlny spájané organickou živickou s jednostranne našitým drôteným pozinkovaným pletivom.



<b>ProRox WM 920</b> ( WM 60)			
hr. (mm)	EUR/m2 bez DPH	m <sup>2</sup> / bal.	m <sup>2</sup> / pal.
50	17,70 €	4,5	94,5
60	20,85 €	4	84
80	25,80 €	3,5	73,5
100	32,30 €	2,5	52,5

Max.500°C. Šírka 0,5m.



<b>ProRox WM 950</b> ( WM 80)			
hr. (mm)	EUR/m2 bez DPH	m <sup>2</sup> / bal.	m <sup>2</sup> / pal.
40	18,05 €	5,5	115,5
50	20,60 €	4	84
60	23,30 €	3,5	73,5
80	28,60 €	3	63
100	34,05 €	2,5	52,5

Max.640°C. Šírka 1m (na obj. 0,5m).

<b>ProRox WM 960</b> (WM 100)			
hr. (mm)	EUR/m2 bez DPH	m <sup>2</sup> / bal.	m <sup>2</sup> / pal.
30	15,85 €	6	126
40	19,85 €	5	105
50	23,95 €	4	84
60	28,15 €	3	63
70	32,55 €	2,5	52,5
80	36,95 €	2,5	52,5
90	41,35 €	2	42
100	45,80 €	2	42

Max.660°C. Šírka 1m.

<b>ProRox WM 970</b>			
hr. (mm)	EUR/m2 bez DPH	m <sup>2</sup> / bal.	m <sup>2</sup> / pal.
50	29,20 €	4	60
60	34,30 €	3	45
80	45,10 €	2,5	37,5
100	55,85 €	2	30

Max.500°C. Šírka 0,5m.

## Voľná vlna



<b>ProRox LF 970D</b>			
hr. (mm)	EUR/kg bez DPH	kg/ bal.	kg/ pal.
-	4,70 €	15	420

Šírka 1m



<b>ProRox GR 903</b>			
hr. (mm)	EUR/kg bez DPH	kg/ bal.	kg/ pal.
-	4,65 €	15	240

## DOSKY

Izolačné dosky z kamennej vlny sú určené pre tepelnú a akustickú izoláciu technických zariadení, ako sú nádrže, pece, kotle, kolóny, dymovody, elektrostatické odlučovače a pod.



<b>ProRox SL 920</b> (Techrock 40)				<b>ProRox SL 930</b> (Techrock 60)				<b>ProRox SL 950</b> (Techrock 80)			
hr. (mm)	EUR/m2 bez DPH	m <sup>2</sup> / bal.	m <sup>2</sup> / pal.	hr. (mm)	EUR/m2 bez DPH	m <sup>2</sup> / bal.	m <sup>2</sup> / pal.	hr. (mm)	EUR/m2 bez DPH	m <sup>2</sup> / bal.	m <sup>2</sup> / pal.
40	8,05 €	7,2	180	40	13,00 €	7,2	72	40	15,30 €	7,2	72
50	10,15 €	4,8	144	50	15,20 €	6	60	50	19,30 €	6	60
60	12,05 €	4,8	120	60	18,25 €	4,8	48	60	23,15 €	4,8	48
80	16,05 €	3,6	90	80	24,35 €	3,6	36	80	30,50 €	3,6	36
100	20,10 €	2,4	72	100	29,55 €	3	30	100	38,20 €	3	30

Max.400°C. Rozmery 0,6 x 1m.

Max.560°C. Rozmery 0,6 x 1m.

Max.640°C. Rozmery 0,6 x 1m.

<b>ProRox SL 960</b> (Techrock 100)				<b>ProRox SL 970</b> (Techrock 120)				<b>ProRox SL 586</b> (Techrock 150)			
hr. (mm)	EUR/m2 bez DPH	m <sup>2</sup> / bal.	m <sup>2</sup> / pal.	hr. (mm)	EUR/m2 bez DPH	m <sup>2</sup> / bal.	m <sup>2</sup> / pal.	hr. (mm)	EUR/m2 bez DPH	m <sup>2</sup> / bal.	m <sup>2</sup> / pal.
40	18,80 €	6	72					40	20,35 €	4,2	75,6
50	22,15 €	4,8	57,6	50	25,10 €	3,6	57,6	50	25,30 €	2,4	62,4
60	26,55 €	3,6	50,4					60	30,35 €	2,4	48
80	36,40 €	3	36								
100	44,20 €	2,4	28,8	100	50,05 €	1,8	28,8	100	50,65 €	1,2	31,2

Max.660°C. Rozmery 0,6 x 1m.

Max.680°C. Rozmery 0,6 x 1m.

Max.700°C. Rozmery 0,6 x 1m.

# Špecialista na pasívnu požiaru ochranu

Promat

## Požiaru ochrana inštalácií TZB



VZT potrubia s požiarou odolnosťou



Potrubia na odvod dymu



Káblové kanály s funkčnou odolnosťou pri požari

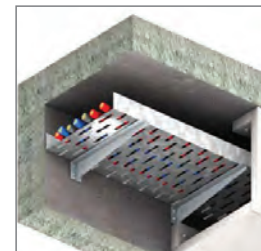

Inštaláčnu kanály

## Požiarne tesnenie prestupov a lineárnych stykov

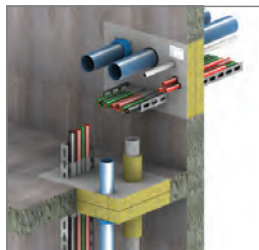

Tesnenie prestupov káblov



Tesnenie prestupov plastových rúr



Tesnenie prestupov kovových rúr

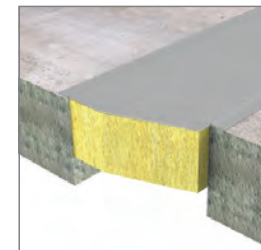

Tesnenie lineárnych stykov





Protipožiarna kalciumsilikátová doska, odolná proti vlhkosti, stabilná a samonosná. Zhotovenie požiarneho konštrukcie podľa požiadaviek EN pre všetky oblasti stavebníctva, napríklad požiarne chránené plechové VZT potrubie, samonosné VZT potrubie s požiarou odolnosťou, potrubie na odvod tepla a spodín horenia.

**PROMATEC® AD**

hr. (mm)	EUR/m <sup>2</sup> bez DPH	m <sup>2</sup> /ks	EUR/ks bez DPH	ks/pal.
40	88 €	3,0	264 €	20

Rozmery 1,2 x 2,5m - 500kg/m<sup>3</sup>

**PROMATEC® L500**

hr. (mm)	EUR/m <sup>2</sup> bez DPH	m <sup>2</sup> /ks	EUR/ks bez DPH	ks/pal.
25	84 €	3,0	252 €	35
30	101 €	3,0	303 €	30
50	167 €	3,0	501 €	16

Rozmery 1,2 x 2,5m - 500kg/m<sup>3</sup>

**PROMATEC® H**

hr. (mm)	EUR/m <sup>2</sup> bez DPH	m <sup>2</sup> /ks	EUR/ks bez DPH	ks/pal.
10	61 €	3,125	190,63 €	40
20	73 €	3,125	228,13 €	20

Rozmery 1,25 x 2,5m - 870kg/m<sup>3</sup>

**Príslušenstvo:**



Promat-K84 grey	Anorganické lepidlo na vzduchotechnické potrubia PROMATEC® a potrubia pre odvod tepla a spodín horenia, pre lepenie protipožiarneho dosiek Promat a minerálnej vlny v špeciálnych požiarneho konštrukcie, pre použitie v požiarneho uzáveroch, vo všetkých interiérových aplikáciách okrem použitia vo vlhkom prostredí.	kg / ks	EUR/kg bez DPH	EUR/ks bez DPH
		15	9,93 €	149 €
		1	12,00 €	12 €

**Požiarne tesnenie prestupov - PROMAT**

Tesnenia prestupov inštalácií cez požiarne steny a stropy.



PROMASEAL®-A	Protipožiarneho jednozložkového tmelu na akrylátovej báze. Vďaka jeho vynikajúcim aplikačným vlastnostiam sa dajú škáry a otvory utiesniť veľmi rýchlo a bezpečne. Tmel sa používa na tesnenie škár v stenách a stropoch s pohybom najviac 7,5%. Môže sa používať ako tesnenie medzi konštrukčnými prvkami stavby a izoláciou.	l / ks	EUR/ks bez DPH	
		0,310	9,00 €	
PROMASEAL®-AG	Protipožiarneho intumescentného tmelu určeného pre tesnenie otvorov v požiarneho stenách a stropoch. Je vhodný pre použitie na tesnenie prestupov káblov, káblových zväzkov, káblových prechodiek, horľavých rúr ako aj horľavých rúr s horľavými izoláciami, ako ochrana proti prestupu ohňa, dymu a tepla.	l / ks	EUR/ks bez DPH	
		0,310	19,00 €	
PROMASTOP®-CC	Protipožiarneho náteru na vodnej báze určeného pre tesnenie otvorov v požiarneho stenách a stropoch. Je vhodný pre použitie na tesnenie prestupov káblov, káblových zväzkov, horľavých a nehorľavých rúr, ako aj pre VZT potrubia s požiarou odolnosťou a na tesnenie lineárnych stykov konštrukcie.	kg / ks	EUR/kg bez DPH	EUR/ks bez DPH
		12,5	20,80 €	260 €
PROMASTOP®-W	Expandujúci protipožiarneho návin, umožňuje zhotoviť ovinutie ľubovoľného Ø priamo na mieste. Je testovaný pre maltové systémy a mäkké upchávkové prestupov cez steny/stropy pre použitie so všetkými bežnými plastovými potrubiami, PVC, PE, PVC, viacvrstvové nízkoohľadné kanalizačné rúry, ako aj izol. AL kompozitné a kovové rúry.	m / ks	EUR/m bez DPH	EUR/ks bez DPH
		18	17,78 €	320 €

**PROMATEC® - systém protipožiarneho ochrany VZT EI 30, 45, 60, 90, 120 min.**

Potrubie max. rozmerov 1,25 x 1m	Potrubie	EI 30	EI 45	EI 60	EI 90	EI 120
Požiar z vonka	↑	25 mm	25 mm	25 mm	25 mm	25 mm
Požiar z vonka	↔	25 mm	25 mm	25 mm	40 mm	40 mm
Požiar z vnútra	↓	25 mm	30 mm	30 mm	50 mm	50 mm
Požiar z vnútra	↔	25 mm	30 mm	30 mm	40 mm	50 mm

Potrubie max. rozmerov 2,3 x 0,85m	Potrubie	EI 30	EI 45	EI 60	EI 90	EI 120
Požiar z vonka	↔	30 mm	30 mm	30 mm	30 mm	50 mm
Požiar z vnútra	↔	30 mm	30 mm	50 mm	50 mm	50 mm

**PROMATEC®- systém pre odvod dymu a tepla EI 30, 60, 120 min.**

Odvod dymu a tepla	Potrubie	EI 30 S 1000 multi	EI 60 S 1500 multi	EI 120 S 1500 multi
Potrubie max.rozmer 1,25 x 1m	↔ ↓	25 mm	30 mm	-
Potrubie max.rozmer 1,25 x 1m	↔	-	-	50mm
Potrubie max.rozmer 2,3 x 0,85m	↔	-	30mm	-
Potrubie max.rozmer 2,3 x 0,85m	↔	-	-	50mm

## ROHOŽE žiaruvzdorné



Izolačná rohož je vyrobená z keramického vlákna, ktoré je netkanou technológiou formované do pevnej, ľahkej a odolnej rohože pre vysoké teploty.

1260°C (96kg/m3)				1260°C (128kg/m3)				* Orientačné rozmery (mm)
hr. (mm)	EUR/m2 bez DPH	EUR/bal. bez DPH	*m <sup>2</sup> /bal.	hr. (mm)	EUR/m2 bez DPH	EUR/bal. bez DPH	*m <sup>2</sup> /bal.	
13	7,28 €	65,00 €	8,93	13	8,51 €	76,00 €	8,93	610 x 14 640
19	10,92 €	65,00 €	5,95	19	12,77 €	76,00 €	5,95	610 x 9 760
25	14,56 €	65,00 €	4,47	25	17,02 €	76,00 €	4,47	610 x 7 320
38	21,84 €	65,00 €	2,98	38	25,53 €	76,00 €	2,98	610 x 4 880
50	29,11 €	65,00 €	2,23	50	34,04 €	76,00 €	2,23	610 x 3 660

\* V závislosti od dostupnosti, môžu byť rohože dodané v inom rozmere.

## PAPIER žiaruvzdorný 1260°C



Papier 1260°C				
Hr. (mm)	EUR/m2 bez DPH	EUR/bal. bez DPH	*m <sup>2</sup> /ks.	* Orientačné rozmery (mm)
1	cena na vyžiadanie		48,8	1 220 x 40 000
2	cena na vyžiadanie		24,4	1 220 x 20 000
3	cena na vyžiadanie		18,3	1 220 x 15 000
4	cena na vyžiadanie		12,2	1 220 x 10 000
5	cena na vyžiadanie		12,2	1 220 x 10 000

\* V závislosti od dostupnosti, môže byť papier dodaný v inom rozmere.

## DOSKY žiaruvzdorné 1260°C

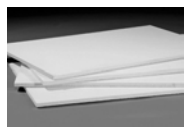

Dosky sú vyrobené z keramických vlákien, organických a anorganických pojív. Izolačné dosky sú vákuovo tvarované výrobky, odolávajú vyšším rýchlostiam spalín v peciach.

Dosky 1260°C				
Hr. (mm)	EUR/m2 bez DPH	EUR/ks bez DPH	*m <sup>2</sup> /ks.	* Orientačné rozmery (mm)
10	cena na vyžiadanie		1,25	1 250 x 1 000
13	cena na vyžiadanie		1,25	1 250 x 1 000
15	cena na vyžiadanie		1,25	1 250 x 1 000
19	cena na vyžiadanie		1,25	1 250 x 1 000
25	cena na vyžiadanie		1,25	1 250 x 1 000
50	cena na vyžiadanie		1,25	1 250 x 1 000

\* V závislosti od dostupnosti, môžu byť dosky dodané v inom rozmere.



## TEMKET snímateľné púzdra



Snímateľné púzdra TEMKET sú určené k eliminácii tepelných strát armatúr, filtrov, šupátok, ventilov, potrubia, kolien a veľa ďalších zariadení. Používajú sa namiesto klasických plechových "snímačiek", a to predovšetkým k výhode rýchleho zloženia a opätovného nasadenia -použitia. Vhodné a ideálne použitie pre kotolne, výmenníkové stanice, v teplárenskom a energetickom priemysle atď.  
 Izolácia slúži ako ochrana pracovníkov pred popálením, sú umývateľné a ich povrch je možné čistiť.

### Zloženie puzdier

Produkt TEMKET je vyrobený zo sklotextílie Temtex s polyuretánovým záterom. Pásy so suchým zipsom slúžia k dokonalému stiahnutiu izolácie a šnúrky na konci stiahnu púzdro k povrchu podkladu.

	Typ armatúry: Ø (mm)	TEMKET UV	TEMKET RV	TEMKET eIV	TEMKET mix	TEMKET UK	TEMKET ZK	TEMKET F	TEMKET ZV	TEMKET KK	TEMKET PR
		Uzatvárací ventil	Regulačný ventil	Elektroventil	Trojcestný ventil	Uzatváracia klapka	Spätná klapka	Filter	Spätný ventil	Guľový ventil	Prírubový spoj
		EUR/ks bez DPH	EUR/ks bez DPH	EUR/ks bez DPH	EUR/ks bez DPH	EUR/ks bez DPH	EUR/ks bez DPH	EUR/ks bez DPH	EUR/ks bez DPH	EUR/ks bez DPH	EUR/ks bez DPH
<b>TEMKET a</b> - púzdra do 150°C (hr. izolácie 40mm)	DN15	52 €	71 €	70 €	106 €	51 €	54 €	56 €	56 €	51 €	50 €
	DN20	55 €	74 €	72 €	109 €	52 €	58 €	60 €	60 €	52 €	52 €
	DN25	55 €	75 €	74 €	110 €	52 €	58 €	62 €	62 €	52 €	52 €
	DN32	58 €	78 €	76 €	114 €	54 €	59 €	66 €	64 €	55 €	54 €
	DN40	59 €	80 €	79 €	118 €	55 €	62 €	70 €	70 €	56 €	56 €
	DN50	62 €	84 €	83 €	125 €	56 €	63 €	75 €	75 €	59 €	58 €
	DN65	68 €	91 €	90 €	135 €	59 €	66 €	90 €	88 €	64 €	60 €
	DN80	71 €	96 €	95 €	142 €	60 €	67 €	95 €	94 €	68 €	62 €
	DN100	78 €	106 €	103 €	155 €	62 €	70 €	102 €	102 €	74 €	63 €
	DN125	90 €	121 €	118 €	178 €	66 €	74 €	121 €	121 €	84 €	67 €
	DN150	111 €	150 €	149 €	222 €	68 €	78 €	146 €	145 €	106 €	71 €
DN200	137 €	185 €	182 €	273 €	74 €	84 €	169 €	168 €	130 €	76 €	
DN250	153 €	208 €	204 €	306 €	82 €	94 €	189 €	188 €	146 €	86 €	
<b>TEMKET b</b> - púzdra do 210°C (hr. izolácie 50mm)	DN15	76 €	92 €	91 €	137 €	68 €	83 €	74 €	74 €	72 €	75 €
	DN20	82 €	96 €	98 €	146 €	71 €	86 €	79 €	79 €	78 €	78 €
	DN25	86 €	103 €	102 €	153 €	71 €	87 €	83 €	82 €	82 €	79 €
	DN32	92 €	110 €	110 €	165 €	72 €	90 €	90 €	88 €	87 €	82 €
	DN40	103 €	122 €	123 €	184 €	75 €	92 €	98 €	96 €	98 €	84 €
	DN50	110 €	131 €	130 €	196 €	76 €	95 €	107 €	107 €	105 €	87 €
	DN65	122 €	158 €	145 €	217 €	80 €	99 €	135 €	135 €	115 €	90 €
	DN80	127 €	163 €	153 €	229 €	82 €	102 €	139 €	138 €	122 €	92 €
	DN100	146 €	182 €	174 €	261 €	84 €	106 €	155 €	154 €	138 €	96 €
	DN125	169 €	212 €	202 €	303 €	87 €	111 €	189 €	188 €	161 €	101 €
	DN150	216 €	251 €	257 €	387 €	92 €	118 €	235 €	232 €	205 €	107 €
DN200	268 €	319 €	319 €	478 €	99 €	127 €	275 €	272 €	255 €	115 €	
DN250	300 €	356 €	356 €	536 €	111 €	142 €	307 €	306 €	284 €	130 €	
<b>TEMKET c</b> - púzdra do 280°C (hr. izolácie 60mm)	DN15	87 €	106 €	113 €	168 €	86 €	103 €	84 €	83 €	83 €	94 €
	DN20	94 €	110 €	119 €	180 €	88 €	107 €	91 €	90 €	88 €	98 €
	DN25	98 €	118 €	126 €	189 €	88 €	109 €	95 €	94 €	92 €	98 €
	DN32	106 €	126 €	135 €	204 €	91 €	111 €	102 €	102 €	101 €	102 €
	DN40	118 €	139 €	151 €	226 €	94 €	115 €	111 €	111 €	111 €	106 €
	DN50	126 €	150 €	161 €	241 €	96 €	119 €	123 €	122 €	119 €	109 €
	DN65	139 €	181 €	178 €	267 €	99 €	123 €	155 €	154 €	131 €	113 €
	DN80	146 €	186 €	188 €	281 €	102 €	127 €	159 €	158 €	139 €	115 €
	DN100	168 €	208 €	214 €	322 €	105 €	131 €	178 €	177 €	158 €	119 €
	DN125	194 €	243 €	249 €	373 €	110 €	138 €	217 €	216 €	184 €	126 €
	DN150	248 €	287 €	318 €	477 €	115 €	146 €	268 €	265 €	235 €	133 €
DN200	307 €	364 €	393 €	590 €	123 €	159 €	314 €	312 €	291 €	145 €	
DN250	343 €	407 €	440 €	659 €	138 €	178 €	351 €	348 €	326 €	161 €	

## PÁSY ArmaGEL HT



tepelnoizolačné vlastnosti dovoľujú použiť menšiu hrúbku izolácie. Izolácia ArmaGel HT má vode odpudivé vlastnosti, znižuje riziko vzniku korózie pod izoláciou. Maximálna teplota použitia +650°C. Súčiniteľ tepelnej vodivosti  $\lambda_{38^\circ\text{C}} = 0,022\text{W/m.K}$ .

### Armagel HT

Hr. izol. (mm)	Rola (šírka 1,5m) Obj. kód	m <sup>2</sup> /bal.	EUR/m <sup>2</sup> bez DPH	Rola (šírka 1m) Obj. kód	m <sup>2</sup> /bal.	EUR/m <sup>2</sup> bez DPH
5	AGH-05-00/150S	24	87,50 €	AGH-05-00/150P	97,5	87,50 €
10	AGH-10-00/150S	12	116,70 €	AGH-10-00/150P	60	116,70 €
15	AGH-15-00/150S	9	173,30 €	AGH-15-00/150P	39	173,30 €
20	AGH-20-00/150S	6	236,30 €	AGH-20-00/150P	30	236,30 €

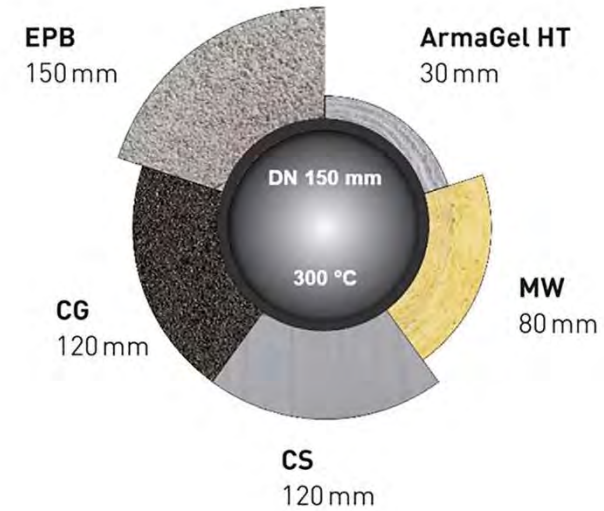



EKAFOL  
EKAMAT



EKATEC  
EKAMET



## EKAFOL Isogenopak® - biela, šedá PVC fólia (Okapak, Durofol)

Tvarovky z PVC fólie bielej farby: Kolená 90°, 45°, T kusy, fólia v roli, čelíčka

Tvarovky z PVC fólie šedej farby: Kolená 90°, 45°, T kusy, fólia v roli, čelíčka, púzdra na armatúry)

### PVC fólia v roli (Plastic foil in rolls)

#### Isogenopak® 350 SE

farba	Šírka:	Bal.:	EUR/m2 bez DPH
biela	1,2m	30 m2	5,90 €
šedá	1 m	35 m2	5,90 €

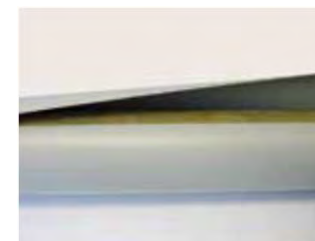
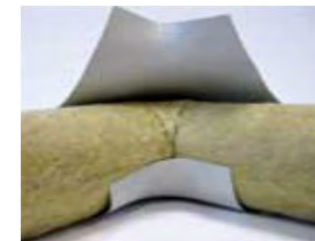
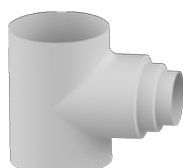

#### T Kus 45°

(Tees diagonal 45°)

Vonk. Ø na izolácii (mm):	Priemer pripojky (mm):	EUR/ks bez DPH
96	80	20,86 €
96	90	24,84 €
103	90	27,88 €
115	90	27,88 €
110	100	27,88 €
116	110	27,88 €
123	110	27,88 €
130	90	30,04 €
136	110	30,04 €
136	136	30,04 €
150	110	43,16 €
156	156	43,16 €
160	160	43,16 €
176	136	56,66 €
176	176	56,66 €
190	180	67,70 €
196	196	75,22 €
203	190	75,22 €
219	190	86,39 €
230	190	101,24 €
236	236	101,24 €
240	240	101,78 €
276	216	102,34 €
276	276	102,57 €

#### T-Kus 90°

(Tees multi fit junction)

Vonk. Ø na izolácii (mm):	Priemer odbočky (mm):	EUR/ks bez DPH
61	61-57	4,64 €
67	67-57	4,67 €
73	73-57	4,71 €
82	82-57	5,31 €
88	88-52	5,66 €
93	93-57	6,49 €
102	102-57	7,17 €
120	120-67	8,40 €
120	120-98	8,40 €
160	160-93	20,81 €

#### Čelíčka

(End caps)

Vonk. Ø na izolácii (mm):	EUR/ks bez DPH
60-70	4,67 €
70-80	5,00 €
80-90	5,21 €
90-100	5,35 €
100-110	5,53 €
110-130	6,21 €
130-150	6,88 €
150-170	7,57 €
170-190	9,02 €
190-210	9,91 €
210-250	11,21 €
250-290	12,40 €
290-330	13,78 €
330-360	32,83 €
360-400	40,64 €
400-440	44,70 €
400-480	48,24 €
480-530	57,80 €
530-580	69,44 €
580-600	75,93 €
600-720	88,70 €

#### Koleno 90°

(Corner elbows 90°)

Vonk. Ø na izolácii (mm):	Obj kód:	EUR/ks bez DPH
40	#2	2,23 €
48	#3	2,42 €
53	#4	2,56 €
63	#5	2,88 €
69	#6	3,35 €
79	#7	3,66 €
83	#8	3,90 €
90	#9	4,21 €
103	#10	5,08 €
115	#11	7,77 €
128	#12	11,36 €
139	#13	12,88 €
160	#14	17,23 €
169	#15	23,58 €

Vonk. Ø potrubia (mm):	90° kolená r=1,5d (90° Bends Norm3: 1,5d)									
	15 mm	20 mm	25 mm	30 mm	40 mm	50 mm	60 mm	70 mm	80 mm	100 mm
15		2,50 €								
18	2,42 €	2,50 €	3,40 €	3,43 €	5,27 €	8,42 €			EUR/ks bez DPH	
22	2,42 €	2,50 €	3,40 €	3,76 €	5,27 €	8,42 €				
28	3,30 €	3,40 €	3,43 €	3,76 €	6,25 €	8,42 €	12,04 €			
35	3,30 €	3,40 €	3,76 €	3,76 €	7,10 €	10,57 €	13,66 €	20,09 €		39,23 €
42	3,40 €	3,76 €	3,76 €	4,97 €	8,34 €	11,65 €	13,66 €	20,98 €	24,07 €	
48	3,76 €	3,76 €	4,75 €	5,11 €	8,34 €	12,04 €	14,91 €	22,28 €	26,37 €	
54	4,68 €	5,11 €		7,10 €	10,81 €	13,83 €				
57/60	4,68 €	5,11 €	6,25 €	7,10 €	10,81 €	14,03 €	18,82 €		26,74 €	48,95 €
64		6,40 €	7,10 €	7,10 €	12,40 €	15,73 €	20,09 €			
70		7,01 €	7,10 €	8,63 €	12,40 €	15,73 €	22,81 €	25,53 €		
76	6,71 €	7,01 €	7,10 €	8,63 €	15,18 €	17,04 €	22,81 €	25,53 €	36,60 €	52,13 €
89		8,34 €	9,53 €	10,81 €	17,04 €	18,72 €	22,81 €	27,59 €	41,12 €	54,79 €
108		10,81 €	15,97 €	15,97 €	19,72 €	21,14 €	25,08 €	34,23 €	42,88 €	55,41 €
114		15,97 €	15,97 €	17,78 €	19,72 €	22,70 €	25,56 €		44,73 €	55,41 €
133			18,47 €	19,72 €	22,70 €	25,08 €	34,40 €	45,99 €	50,39 €	61,11 €
140			19,72 €	21,14 €	22,70 €	26,25 €	34,40 €	45,99 €	52,29 €	61,11 €
159			21,14 €	22,70 €	25,08 €	34,40 €	40,83 €	46,57 €	58,72 €	68,43 €
168			22,70 €	25,08 €	26,25 €	37,34 €	52,29 €	57,70 €	66,77 €	74,82 €
194				44,87 €	48,97 €	53,93 €	58,37 €		66,77 €	87,80 €
219			41,12 €	44,87 €	55,42 €	60,27 €	67,67 €		78,43 €	104,81 €
245						69,05 €			86,21 €	114,02 €
267						74,85 €	77,58 €		98,04 €	123,33 €
273						86,07 €			109,49 €	

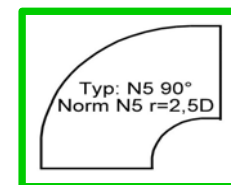
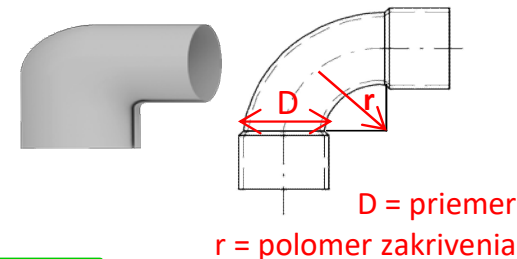
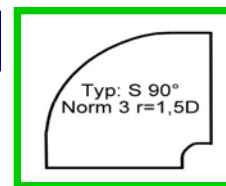

Vonk. Ø potrubia (mm):	90° kolená r=2,5d (90° Bends Norm5: 2,5d)			
	15 mm	20 mm	25 mm	30 mm
22	3,35 €	3,43 €		
28	3,35 €	4,87 €	5,51 €	5,92 €
35	3,71 €	4,87 €	5,92 €	
42	5,10 €	5,14 €	8,09 €	11,28 €
48		6,34 €		12,18 €
57/60		8,09 €		16,52 €
64				
70	8,09 €	11,39 €	EUR/ks bez DPH	
76				
89				26,32 €

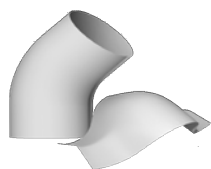
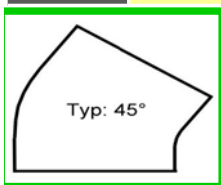

45° kolená (45° Bends)															
Vonk. Ø na izolácii (mm):	Použitie na izoláciu:	Koleno z jedného kusa	Koleno zlepené z dvoch častí	Vonk. Ø na izolácii (mm):	Použitie na izoláciu:	Koleno z jedného kusa	Koleno zlepené z dvoch častí	Vonk. Ø na izolácii (mm):	Použitie na izoláciu:	Koleno z jedného kusa	Koleno zlepené z dvoch častí	Vonk. Ø na izolácii (mm):	Použitie na izoláciu:	Koleno z jedného kusa	Koleno zlepené z dvoch častí
52	12-20	2,77 €		85	35-25		4,22 €	120	60-30		7,85 €	180	76-50	16,94 €	16,83 €
58	18-20	3,20 €	2,80 €	88	28-30		4,26 €	128	48-40	8,34 €	8,30 €	189	89-50		20,58 €
62	22-20	3,24 €	2,83 €	92	42-25	5,00 €	4,83 €	136	76-30		8,88 €	193	114-40	19,65 €	
68	28-20		2,83 €	95	35-30		5,08 €	141	60-40	10,79 €	10,70 €	206	108-50	21,01 €	
72	22-25	3,73 €		98	48-25		5,10 €	149	89-30		10,95 €	219	114-50	22,63 €	
75	35-20		3,73 €	102	22-40	5,14 €	5,55 €	154	76-40	15,14 €	15,08 €	232	133-50	28,60 €	
78	28-25		3,73 €	110	60-25		6,62 €	160	60-50		16,35 €	245	140-50	29,91 €	
82	42-20	4,42 €		115	35-40	7,04 €	6,98 €	167	89-40	16,94 €	16,83 €	271	168-50	36,95 €	

## EKATEC - pokovená PVC fólia (Isogenotec)

UV odolné tvarovky z PVC fólie kovovo lesklej farby (alternatíva povrchov SILVER CLAD, AL CLAD, ALU TEC a pod.). Používa sa ako povrchová ochrana izol. v interiéri a exteriéri.

### PVC fólia v roli - kovovo leská (Plastic foil in rolls)

EKATEC / ISOGENOTEC®	Hr.	Šírka:	Bal.:	EUR/m <sup>2</sup> bez DPH
	0,35mm	1,2m	30 m <sup>2</sup>	11,00 €



Vonk. Ø potrubia (mm):	90° kolená r=1,5d (90° Bends Norm3: 1,5d)									
	20 mm	25 mm	30 mm	40 mm	50 mm	60 mm	70 mm	80 mm	100 mm	
12	5,09 €									
18	5,09 €	5,83 €	6,59 €	10,38 €	15,65 €					
22	5,17 €	6,30 €	6,79 €	10,38 €	16,28 €					
28	5,39 €	6,77 €	8,06 €	10,67 €	16,93 €					
35	6,29 €	8,28 €	8,67 €	16,93 €	17,39 €	27,08 €				71,96 €
42	6,98 €	8,89 €	10,33 €	17,39 €	18,00 €	28,35 €		50,82 €		
48	9,22 €	9,95 €	10,91 €	17,78 €	23,28 €	29,45 €	39,15 €	52,92 €		
54	9,45 €		11,41 €		24,15 €					
57/60	9,95 €	12,90 €	13,36 €	19,92 €	28,42 €	29,62 €		52,92 €	79,16 €	
64	12,28 €		17,91 €		29,59 €	30,07 €				
70	17,39 €	17,97 €	18,53 €	26,79 €	32,22 €	31,09 €	40,23 €			
76	17,90 €	18,21 €	18,53 €	29,62 €	32,22 €	44,35 €	46,56 €	52,92 €	81,11 €	
89	18,63 €	21,83 €	25,40 €	30,07 €	34,27 €	46,82 €	52,92 €	62,66 €	82,73 €	
102	30,68 €	31,53 €	31,98 €	31,75 €	36,22 €					
108	32,63 €	33,83 €	34,27 €	41,06 €	46,15 €	57,57 €	62,44 €	76,18 €	86,59 €	
114	33,05 €	34,27 €	35,68 €	42,78 €	46,56 €	60,97 €		76,18 €	88,48 €	
133		55,14 €	57,39 €	74,72 €	76,18 €	84,05 €	78,33 €	97,81 €	91,02 €	
140		57,67 €	79,59 €	76,64 €	77,92 €	88,27 €		104,79 €	115,67 €	
159		63,85 €	81,86 €	78,10 €	80,42 €	93,15 €			124,54 €	
168		69,43 €	84,49 €	108,18 €	116,38 €	119,62 €		112,61 €	135,04 €	
194			89,31 €	118,51 €	118,51 €	120,68 €		148,00 €	148,18 €	
219		71,11 €	91,87 €	121,69 €	123,63 €	147,75 €		149,23 €	150,30 €	
245					147,75 €			150,30 €		
267					147,75 €			150,30 €	150,30 €	
273					147,75 €			150,30 €		



### Koleno 90° (Corner elbows 90°)

Vonk. Ø na izolácii (mm):	Obj kód:	EUR/ks bez DPH
40	#2	4,85 €
48	#3	5,09 €
53	#4	5,29 €
63	#5	5,58 €
69	#6	6,20 €
79	#7	6,92 €
83	#8	8,11 €
90	#9	9,07 €
103	#10	10,50 €
115	#11	19,92 €
128	#12	29,62 €
139	#13	31,98 €
160	#14	42,78 €
169	#15	46,56 €

### 45° Kolená (45° Bends)

Vonk. Ø na izolácii (mm):	Použitie na izolácii:	EUR/ks bez DPH
40	21-09	4,87 €
52	12-20	5,09 €
58	18-20	5,09 €
62	21-20	5,17 €
72	21-25	6,30 €
82	42-20	6,98 €
92	42-25	8,89 €
102	22-40	10,38 €
115	35-40	16,93 €
128	48-40	17,78 €
141	60-40	19,92 €
154	76-40	29,62 €
167	89-40	30,07 €
180	76-50	32,22 €
193	114-40	42,78 €
206	108-50	46,15 €
219	114-50	46,56 €
232	133-50	76,18 €
245	140-50	77,92 €
258	159-50	80,42 €
271	168-50	116,38 €

### T-Kus 90° (Tees multi fit junction)

Vonk. Ø na izolácii (mm):	Priemer odbočky (mm):	EUR/ks bez DPH	Vonk. Ø na izolácii (mm):	Priemer odbočky (mm):	EUR/ks bez DPH
61	61-57	6,07 €	93	93-57	12,90 €
67	67-57	6,79 €	102	102-57	14,16 €
73	73-57	7,34 €	120	120-67	17,25 €
82	82-57	8,11 €	120	120-98	17,25 €
88	88-52	10,63 €	160	160-93	44,46 €



### Čelička (End caps)

Vonk. Ø na izolácii (mm):	EUR/ks bez DPH	Vonk. Ø na izolácii (mm):	EUR/ks bez DPH	Vonk. Ø na izolácii (mm):	EUR/ks bez DPH	Vonk. Ø na izolácii (mm):	EUR/ks bez DPH
60-70	6,25 €	110-130	9,71 €	210-250	18,04 €	400-440	51,52 €
70-80	6,43 €	130-150	11,05 €	250-290	33,10 €	400-480	52,01 €
80-90	6,59 €	150-170	12,50 €	290-330	38,69 €	480-530	88,72 €
90-100	7,09 €	170-190	13,94 €	330-360	42,54 €	530-580	108,88 €
100-110	7,83 €	190-210	15,41 €	360-400	48,89 €	580-600	116,24 €
						600-720	135,85 €

## EKAMAT- embasovaná AL fólia (Okatherm)

Tvarovky z hliníkovej fólie, embasovaný AL 99,5% (Kolená 90°, 45°, T kusy, púzdra na ventily).

Hrúbka 0,2 (na vyžiadanie 0,3mm).

### AL fólia v roli - embasovaný hliníkový plech

EKAMAT / OKATHERM	Hr.	Šírka:	Bal.:	EUR/m2 bez DPH
	0,2 mm	1 m	25 m2	9,00 €



Vonk. Ø potrubia (mm):	90° Kolená 1,5d (90° Bends Norm3: 1,5d)									
	13 mm	20 mm	25 mm	30 mm	35 mm	40 mm	50 mm	60 mm	80 mm	100 mm
12		5,88 €								
15	6,08 €			7,56 €						
18	6,08 €	6,08 €	6,57 €	7,56 €	7,71 €	8,63 €	10,33 €			
22	6,33 €	6,33 €	6,93 €	7,67 €	8,13 €	8,63 €	10,33 €			
28	6,57 €	6,57 €	7,67 €	7,71 €	8,63 €	8,78 €	12,36 €			
35	6,33 €	6,93 €	7,67 €	8,13 €	8,63 €	9,76 €	13,37 €		EUR/ks bez DPH	
38		7,67 €		8,63 €		10,33 €				
42/44	6,57 €	7,67 €	8,13 €	8,63 €	9,76 €	10,33 €	13,65 €	21,71 €		
48	6,93 €	7,71 €	8,63 €	8,78 €	9,76 €	12,36 €	18,07 €	21,71 €		
54				9,76 €	10,33 €	13,37 €	18,07 €	23,32 €		
57/60	7,67 €	8,63 €	8,78 €	9,76 €	12,36 €	13,37 €	18,07 €	23,32 €	36,05 €	
64		8,78 €	9,76 €	10,33 €	12,73 €	13,65 €	21,71 €	28,49 €	36,05 €	
70	8,63 €	8,78 €	9,76 €	12,36 €	13,37 €	18,07 €	21,71 €	28,49 €	39,67 €	
76		9,76 €	10,33 €	12,73 €	17,65 €	18,07 €	23,32 €	28,49 €	39,67 €	
89		12,36 €	12,73 €	17,65 €	19,68 €	21,71 €	28,49 €	28,75 €	42,90 €	52,03 €
102		17,65 €	19,68 €	19,68 €	21,71 €	28,49 €	28,75 €	36,05 €	46,91 €	
108		17,65 €	19,68 €	21,71 €	23,32 €	28,49 €	28,75 €	36,05 €	46,91 €	62,68 €
114		19,68 €	21,71 €	23,32 €	28,49 €	28,49 €	37,53 €	39,67 €	55,34 €	62,68 €
127		21,71 €	23,32 €	28,49 €	28,49 €	28,75 €	36,05 €	42,19 €	60,86 €	
133		23,32 €	28,49 €	28,49 €	28,75 €	32,88 €	39,67 €	43,94 €	62,68 €	65,62 €
140		28,49 €	28,49 €	28,75 €		37,53 €	42,19 €	45,03 €	62,68 €	70,90 €
159		28,49 €	28,75 €	37,53 €		42,19 €	45,03 €	55,34 €	65,62 €	73,19 €
169			37,53 €	36,05 €		42,19 €	46,15 €	60,86 €	70,90 €	



### Kolená 45° (Bends 45°0,2mm)

Vonk. Ø na izol. (mm):	Použitie na izoláciu:	EUR/ks bez DPH
62	21-20	5,96 €
72	33-20	6,12 €
82	42-20	6,62 €
95	33-30	6,62 €
102	42-30	7,92 €
108	48-30	7,92 €
115	35-40	7,92 €
122	42-40	7,92 €
128	48-40	7,92 €
141	62-40	8,98 €
154	76-40	9,44 €
167	89-40	11,64 €
184	60-60	12,39 €
193	114-40	13,06 €
215	114-50	15,40 €
236	114-60	17,60 €
258	159-50	20,47 €
300	194-50	23,22 €
345	140-100	36,54 €

### T-Kus 90° (Tees 0,2mm)

Vonk. Ø na izol. (mm):	EUR/ks bez DPH
58	5,96 €
62	6,12 €
68	6,62 €
68	6,62 €
75	7,92 €
81	7,92 €
84	7,92 €
87	8,13 €
95	8,87 €
104	8,87 €
108	9,09 €



DN	EKAMAT Boxes púzdra na ventily (hr. 0,2mm)			Box-šikmý ventil	Box-kolmý ventil	Box-guľový ventil	Box-komb. ventilov
	Použitie pre potrubie:			EUR/ks bez DPH	EUR/ks bez DPH	EUR/ks bez DPH	EUR/ks bez DPH
	Fe	Cu	Hr. izol.				
15	21	18	20-27	28,53 €	24,34 €	24,34 €	30,81 €
20	27	22	20-31	30,81 €	26,98 €	26,98 €	35,18 €
25	34	28	30-38	35,18 €	32,19 €	32,19 €	42,24 €
32	42	35	30-45	42,24 €	37,95 €	37,95 €	
40	48	42	40-48	48,51 €	41,11 €	41,11 €	
50	60	54	50-59	65,04 €	50,91 €	50,91 €	

### Príslušenstvo k PVC povrchom

(Ekafol, Isogenopak, Okapak, Ekatec, Isogenotec, ArmaChek Silver, Kaiflex Protect ALuTec, AL Clad a pod.)

P.č.	Položka	Popis	MJ	EUR/MJ bez DPH
1	PVC šedá páska 25m x 25mm	PVC-self adhesive tape grey, width 25 mm, length 25 m	ks	8,00 €
2	PVC šedá páska 25m x 30mm	PVC-self adhesive tape grey, width 30 mm, length 25 m	ks	8,00 €
3	PVC biela páska 33m x 30mm	EKAFIX self adhesive tape white, width 30 mm, length 33 m	ks	9,40 €
4	SILVER CLAD páska do exteriéru 25m x 19mm	EKAFIX self adhesive tape silver, width 19 mm, length 25 m	ks	7,70 €
5	SILVER CLAD páska do exteriéru 25m x 25mm	EKAFIX self adhesive tape silver, width 25 mm, length 25 m	ks	10,10 €
6	SILVER CLAD páska do exteriéru 30m x 25mm	EKAFIX self adhesive tape, silver, width 30 mm, length 25 m	ks	12,10 €
7	SILVER CLAD páska do exteriéru 50m x 50mm	EKAFIX self adhesive tape, silver, width 50 mm, length 50 m	ks	40,70 €
8	EKAFIX hladítko na pásky	EKAFIX spatula for tapes	ks	2,90 €
9	EKAFIX plastové nity biele alebo šedé (1000ks/bal.)	EKAFIX PVC rivets white and grey	bal	7,90 €
10	EKAFIX nitovač rovný / bočný	EKAFIX tool for rivet strait / angle	ks	5,60 €
11	EKAFIX nitovač kombinovaný	EKAFIX tool for rivet combination of strait and angle	ks	5,60 €
12	EKAFIX nitovač kombinovaný PREMIUM	EKAFIX rivet tool PREMIUM combination of strait and angle	ks	12,20 €
13	Rezací stół 1 m	EKAFIX cutting table, 1 m width, for PVC-roles	ks	- €
14	Rezací stół 1,2 m	EKAFIX cutting table, 1,2 m width for PVC-Roles	ks	- €
15	Rezací stół 1,4 m	EKAFIX cutting table, 1,4 m width for PVC-Roles	ks	- €
16	EKAFIX nohy pre rezací stół	EKAFIX legs for EKAFIX – cutting table	ks	- €
17	EKAFIX príložník/pravítko 1 m	EKAFIX measure profile for cutting table 1 m	ks	- €
18	EKAFIX príložník/pravítko 1,2 m	EKAFIX measure profile for cutting table 1,2 m	ks	- €
19	EKAFIX príložník/pravítko 1,4 m	EKAFIX measure profile for cutting table 1,4 m	ks	- €
20	EKAFIX rotačný nôž	EKAFIX Role knife	ks	- €
21	EKAFIX náhradne čepele pre rotačný nôž	EKAFIX Role knif- blade	ks	- €
22	Nôž 6"	EKAFIX knife for insulation material, 6"	ks	- €
23	Nožnice 9"	EKAFIX scissors , 9"	ks	- €

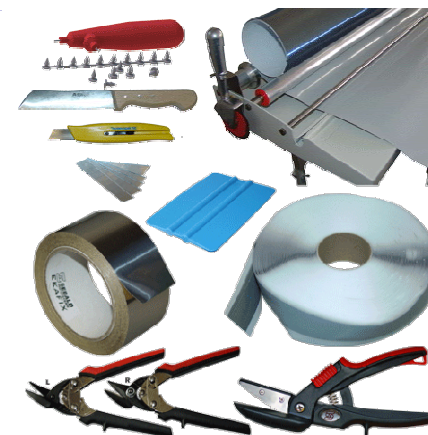

### Príslušenstvo k AL embasovanému plechu

(Ekamat, Okatherm)

P.č.	Položka	Popis	MJ	EUR/MJ bez DPH
1	Nitovač pre kovové nity	EKAFIX tool for metal rivets	ks	53,50 €
2	Kovové nity (100ks/bal.)	EKAFIX rivets, stainless steel	bal	70,80 €
3	Sponkovačka	EKAFIX tacker for jacketing system	ks	207,20 €
4	Zásobník do sponkovačky	EKAFIX nose for tacker L4C5	ks	30,10 €
5	Sponky 15mm nerezové (5000ks/bal.)	EKAFIX staples 1/2" for EKAFIX tacker	bal.	99,60 €
6	Sponky 22mm pozinkované (5000ks/bal.)	EKAFIX staples 3/8" for EKAFIX tracker	bal.	30,10 €
7	Sponkovačka Spredex 7	EKAFIX tacker	ks	129,10 €
8	Sponky 10mm pozinkované (5000ks/bal.)	EKAFIX staples 11/10mm for tacker Spredex 7 (galvanized)	bal.	20,30 €
9	Plastové nity (1000ks/bal.)	EKAFIX plastic rivets for EKAMAT	bal	23,50 €
10	Nitovač k plastovým nitom	EKAFIX tool, straight or angled for plastic rivets	ks	7,50 €





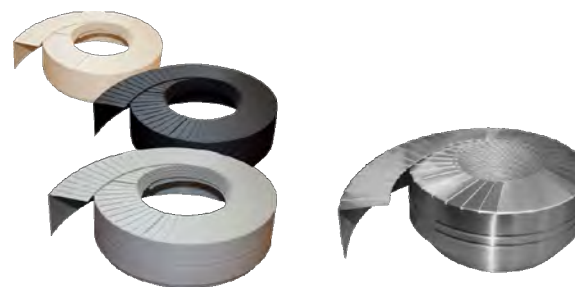
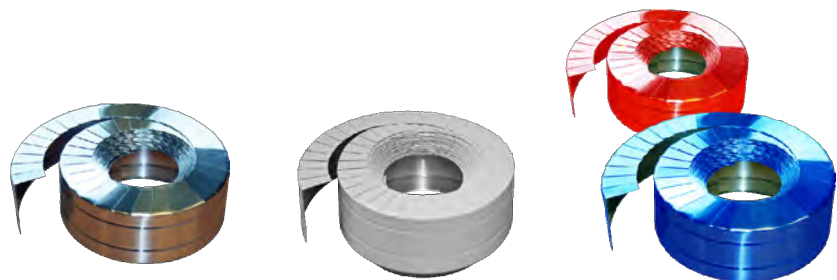

EKALIT	AL- ukončovacie pásy					
	čistá (AL)		šedá		červená modrá	
Šírka (mm)	EUR/bm bez DPH	EUR/ks bez DPH	EUR/bm bez DPH	EUR/ks bez DPH	EUR/bm bez DPH	EUR/ks bez DPH
10	2,70 €	27 €	3,10 €	31 €		
15	2,70 €	27 €	3,10 €	31 €		
20	2,70 €	27 €	3,10 €	31 €	3,50 €	35 €
25	3,10 €	31 €	3,50 €	35 €	3,80 €	38 €
30	3,10 €	31 €	3,50 €	35 €	3,80 €	38 €
40	4,20 €	42 €	4,90 €	49 €	5,40 €	54 €
50	4,80 €	48 €	5,70 €	57 €	6,30 €	63 €
60	5,50 €	55 €	6,80 €	68 €	7,20 €	72 €
70	6,30 €	63 €	7,70 €	77 €		
80	7,20 €	72 €	8,80 €	88 €		
100	9,20 €	92 €	10,80 €	108 €		

1ks =10bm ( v kartóne celkom 5ks)

EKATEC	PVC - ukončovacie pásy			
	šedá čierna biela		EKATEC (kovovo lesklá)	
Šírka (mm)	EUR/bm bez DPH	EUR/ks bez DPH	EUR/bm bez DPH	EUR/ks bez DPH
10				
15	3,50 €	17,50 €	7,70 €	38,50 €
20	3,50 €	17,50 €	7,70 €	38,50 €
25	3,80 €	19,00 €	8,60 €	43,00 €
30	3,80 €	19,00 €	8,60 €	43,00 €
40	5,40 €	27,00 €	10,20 €	51,00 €
50	6,30 €	31,50 €	11,10 €	55,50 €

1ks =5bm ( v kartóne celkom 5ks)

## Oplechovanie EKAMET / OKABELL

Pozink. plech (Galvanized steel)

Hliníková plech odolný voči morskéj vode (Aluminum seawater resistant)

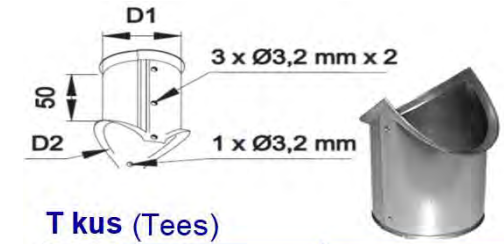
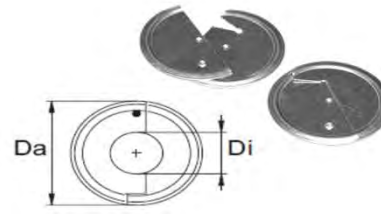
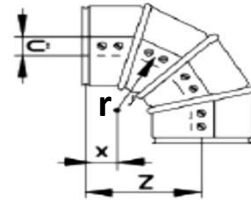
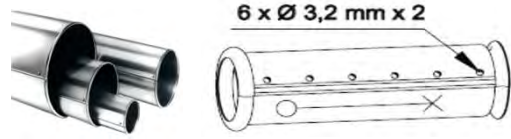

### Rovný kus 1m (Straight jackets)

Ø (mm)	Pozinkovaný plech		Hliníkový plech	
	Hr. (mm)	EUR/ks bez DPH	Hr. (mm)	EUR/ks bez DPH
70	0,4	17 €	0,5	21 €
80	0,4	18 €	0,5	22 €
90	0,4	19 €	0,5	24 €
100	0,4	20 €	0,5	25 €
110	0,5	23 €	0,5	27 €
120	0,5	24 €	0,5	28 €
130	0,5	26 €	0,6	32 €
140	0,5	28 €	0,6	35 €
150	0,5	29 €	0,6	37 €
160	0,6	35 €	0,6	39 €
170	0,6	37 €	0,6	41 €
180	0,6	39 €	0,6	43 €
190	0,6	40 €	0,6	45 €
200	0,6	42 €	0,6	47 €
210	0,6	44 €	0,6	50 €
220	0,6	45 €	0,6	52 €
230	0,6	47 €	0,6	54 €
240	0,6	48 €	0,6	57 €
250	0,6	50 €	0,6	59 €
260	0,7	59 €	0,8	83 €
270	0,7	61 €	0,8	86 €
280	0,7	63 €	0,8	88 €
290	0,7	65 €	0,8	91 €
300	0,7	67 €	0,8	94 €
310	0,7	70 €	0,8	97 €
320	0,7	72 €	0,8	99 €
330	0,7	74 €	0,8	102 €
340	0,7	76 €	0,8	105 €
350	0,7	78 €	0,8	107 €
360	0,7	80 €	0,8	110 €
370	0,7	82 €	0,8	112 €
380	0,7	84 €	0,8	117 €

### Kolená 90° (Segment-bends)

Ø (mm)	Rádus r (mm)	Segmentov (ks):	Pozinkovaný plech		Hliníkový plech	
			Hr. (mm)	EUR/ks bez DPH	Hr. (mm)	EUR/ks bez DPH
70	55	4	0,5	12 €	0,5	15 €
80	60	4	0,5	13 €	0,5	15 €
90	60	4	0,5	13 €	0,5	16 €
100	70	4	0,5	14 €	0,5	17 €
110	70	4	0,5	15 €	0,5	18 €
120	80	4	0,5	16 €	0,5	19 €
130	80	4	0,6	17 €	0,6	20 €
140	90	4	0,6	18 €	0,6	21 €
150	90	4	0,6	19 €	0,6	22 €
160	95	4	0,6	20 €	0,6	23 €
170	100	4	0,6	23 €	0,6	27 €
180	110	4	0,6	24 €	0,6	28 €
190	110	4	0,6	25 €	0,6	30 €
200	125	4	0,6	26 €	0,6	31 €
210	120	4	0,6	28 €	0,6	32 €
220	130	4	0,6	29 €	0,6	34 €
230	130	4	0,6	30 €	0,6	36 €
240	145	4	0,6	32 €	0,6	38 €
250	155	4	0,6	35 €	0,6	41 €
260	160	4	0,7	41 €	0,8	51 €
270	170	4	0,7	43 €	0,8	53 €
280	175	4	0,7	44 €	0,8	55 €
290	180	4	0,7	46 €	0,8	58 €
300	185	4	0,7	48 €	0,8	60 €
310	190	4	0,7	50 €	0,8	62 €
320	190	4	0,7	52 €	0,8	65 €
330	195	4	0,7	53 €	0,8	67 €
340	200	4	0,7	56 €	0,8	70 €
350	210	4	0,7	59 €	0,8	74 €
360	215	4	0,7	62 €	0,8	78 €
370	230	4	0,7	68 €	0,8	85 €
380	270	5	0,7	74 €	0,8	92 €

### Čelička (End caps)

Ø (mm)	Pozinkovaný plech		Hliníkový plech	
	Ø (mm)	EUR/ks bez DPH	Ø (mm)	EUR/ks bez DPH
70	4,8 €	70	5,70 €	
80	5,0 €	80	5,80 €	
90	5,2 €	90	6,00 €	
100	5,3 €	100	6,20 €	
110	5,6 €	110	6,40 €	
120	5,7 €	120	6,50 €	
130	5,9 €	130	6,70 €	
140	6,1 €	140	6,90 €	
150	6,3 €	150	7,20 €	
160	6,5 €	160	7,40 €	
170	6,8 €	170	7,70 €	
180	7,1 €	180	7,90 €	
190	7,7 €	190	8,80 €	
200	8,3 €	200	9,30 €	
210	8,7 €	210	10 €	
220	9,2 €	220	10 €	
230	10 €	230	11 €	
240	10 €	240	11 €	
250	11 €	250	14 €	
260	12 €	260	14 €	
270	12 €	270	15 €	
280	13 €	280	16 €	
290	13 €	290	17 €	
300	14 €	300	17 €	
310	15 €	310	18 €	
320	16 €	320	19 €	
330	16 €	330	20 €	
340	17 €	340	21 €	
350	18 €	350	22 €	
360	19 €	360	23 €	
370	20 €	370	24 €	
380	20 €	380	25 €	

### T kus (Tees)

Ø (mm)	Pozinkovaný plech		Hliníkový plech	
	Hr. (mm)	EUR/ks bez DPH	Hr. (mm)	EUR/ks bez DPH
70	0,5	27 €	0,6	29 €
80	0,5	28 €	0,6	31 €
90	0,5	30 €	0,6	33 €
100	0,5	32 €	0,6	35 €
110	0,5	33 €	0,6	37 €
120	0,5	35 €	0,6	39 €
130	0,6	38 €	0,8	43 €
140	0,6	40 €	0,8	45 €
150	0,6	42 €	0,8	47 €
160	0,6	44 €	0,8	49 €
170	0,6	46 €	0,8	52 €
180	0,6	48 €	0,8	54 €
190	0,6	49 €	0,8	56 €
200	0,6	53 €	0,8	59 €
210	0,6	55 €	0,8	61 €
220	0,6	57 €	0,8	64 €
230	0,6	59 €	0,8	66 €
240	0,6	61 €	0,8	69 €
250	0,6	63 €	0,8	72 €
260	0,7	65 €	1	75 €
270	0,7	70 €	1	77 €
280	0,7	72 €	1	80 €
290	0,7	74 €	1	82 €
300	0,7	76 €	1	85 €

Ø (mm)	Pozinkovaný plech		Hliníkový plech		Ø (mm)	Rádus r (mm)	Segmentov (ks):	Pozinkovaný plech		Hliníkový plech		Pozinkovaný plech		Hliníkový plech	
	Hr. (mm)	EUR/ks bez DPH	Hr. (mm)	EUR/ks bez DPH				Hr. (mm)	EUR/ks bez DPH	Hr. (mm)	EUR/ks bez DPH	Ø (mm)	EUR/ks bez DPH	Ø (mm)	EUR/ks bez DPH
390	0,7	89 €	0,8	120 €	390	270	5	0,7	81 €	0,8	99 €	390	21 €	390	26 €
400	0,7	92 €	0,8	123 €	400	280	5	0,7	86 €	0,8	106 €	400	22 €	400	27 €
410	0,7	94 €	0,8	126 €	410	280	5	0,7	91 €	0,8	113 €	410	23 €	410	28 €
420	0,7	96 €	0,8	129 €	420	305	5	0,7	94 €	0,8	118 €	420	24 €	420	29 €
430	0,7	98 €	0,8	132 €	430	310	5	0,7	97 €	0,8	122 €	430	25 €	430	31 €
440	0,7	100 €	0,8	134 €	440	320	6	0,7	100 €	0,8	126 €	440	25 €	440	32 €
450	0,7	102 €	0,8	137 €	450	330	6	0,7	104 €	0,8	131 €	450	26 €	450	33 €
460	0,7	104 €	0,8	140 €	460	340	6	0,7	107 €	0,8	137 €	460	27 €	460	34 €
470	0,7	106 €	0,8	143 €	470	360	6	0,7	112 €	0,8	143 €	470	28 €	470	35 €
480	0,7	108 €	0,8	146 €	480	380	6	0,7	116 €	0,8	150 €	480	29 €	480	37 €

Základné údaje oplechovania pre objednávku:

#### Rovný kus

Por. č.	Plech:	Typ (štandard pozitív -negatív):	Hr. (mm)	Ø (mm)		Dĺžka (mm)	Počet ks:

Štandard rovných kusov:  
6x prevrtanie, dĺžka 1000mm,  
olemovanie (pozitív - negatív):

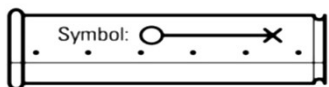

#### Koleno

Por. č.	Plech:	Typ (štandard 90° E4 C):	Hr. (mm)	Ø (mm)	r (mm):	Segmentov (ks)	Počet ks:

Štandard kolien: dierovanie,  
olemovanie E4 (C) (negatív-negatív)

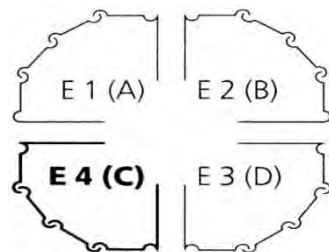

#### Čeličko, T-Kus alebo zúženie.

Por. č.	Plech:	Typ:	Hr. (mm)	Ø Da / D1 mm	Ø Di / D2 (mm)	Dĺžka (mm):	Počet ks:

## Oplechovanie EKAMET / OKABELL

### Kryt na príruby

(Flange box)

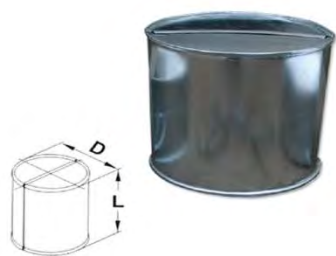
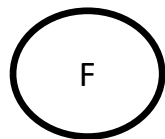

### Kryt jednoduchý

(Case box)

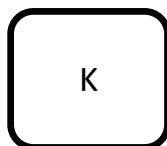

### Kryt na ventil

(Valve box)

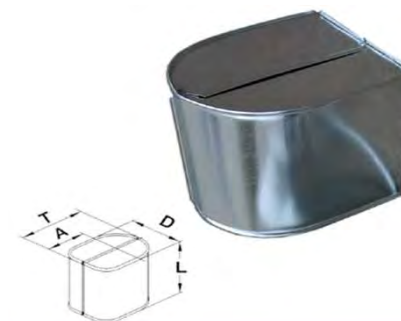
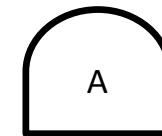

#### Pozink. plech (Galvanized steel)

D (mm)	2 x D (mm)	Hr. (mm)	Výška L:			
			300mm	500mm	750mm	980mm
			EUR/ks bez DPH	EUR/ks bez DPH	EUR/ks bez DPH	EUR/ks bez DPH
150	300	0,6	69 €	71 €	77 €	90 €
160	320	0,6	71 €	73 €	79 €	94 €
170	340	0,6	72 €	75 €	82 €	98 €
175	350	0,6				
180	360	0,6	73 €	78 €	85 €	101 €
190	380	0,6				
200	400	0,6	77 €	83 €	91 €	110 €
205	410	0,6				
210	420	0,6	79 €	85 €	94 €	113 €
215	430	0,6				
220	440	0,6	81 €	88 €	97 €	117 €
230	460	0,6	83 €	90 €	100 €	121 €
235	470	0,6				
240	480	0,6	85 €	92 €	103 €	125 €
250	500	0,6	87 €	95 €	106 €	127 €
260	520	0,6				
270	540	0,7	92 €	104 €	118 €	138 €
285	570	0,7				
290	580	0,7	99 €	110 €	125 €	146 €
300	600	0,7	100 €	112 €	127 €	150 €
310	620	0,7				
320	640	0,7	105 €	117 €	134 €	157 €
330	660	0,7				
340	680	0,7				
350	700	0,7	112 €	126 €	144 €	170 €
360	720	0,7	114 €	128 €	146 €	173 €
375	750	0,7				
380	760	0,7				
400	800	0,8	131 €	149 €	172 €	191 €
410	820	0,8	132 €	151 €	175 €	193 €
420	840	0,8	133 €	153 €	177 €	200 €

#### Pozink. plech (Galvanized steel)

D + T (mm)	Hr. (mm)	Výška L:			
		300mm	500mm	750mm	980mm
		EUR/ks bez DPH	EUR/ks bez DPH	EUR/ks bez DPH	EUR/ks bez DPH
300	0,6				
320	0,6	69 €	75 €	83 €	92 €
340	0,6				
350	0,6	70 €	77 €	87 €	95 €
360	0,6				
380	0,6	72 €	80 €	90 €	99 €
400	0,6				
410	0,6	74 €	83 €	93 €	104 €
420	0,6				
430	0,6				
440	0,6	76 €	86 €	98 €	108 €
460	0,6				
470	0,6	78 €	88 €	101 €	113 €
480	0,6				
500	0,6	80 €	91 €	104 €	118 €
520	0,6				
540	0,7	95 €	108 €	126 €	142 €
570	0,7				
580	0,7	99 €	113 €	131 €	148 €
600	0,7				
620	0,7	103 €	118 €	137 €	155 €
640	0,7				
660	0,7	106 €	123 €	143 €	162 €
680	0,7				
700	0,7	109 €	127 €	149 €	169 €
720	0,7				
750	0,7	114 €	133 €	156 €	178 €
760	0,7				
800	0,8	123 €	145 €	172 €	197 €
820	0,8				
840	0,8				

#### Pozink. plech (Galvanized steel)







D + T (mm)	Hr. (mm)	Výška L:			
		300mm	500mm	750mm	980mm
		EUR/ks bez DPH	EUR/ks bez DPH	EUR/ks bez DPH	EUR/ks bez DPH
300	0,6				
320	0,6				
340	0,6	81 €	87 €	95 €	103 €
350	0,6				
360	0,6				
380	0,6	83 €	90 €	100 €	109 €
400	0,6				
410	0,6	85 €	93 €	103 €	113 €
420	0,6				
430	0,6	87 €	95 €	106 €	116 €
440	0,6				
460	0,6	101 €	110 €	122 €	133 €
470	0,6				
480	0,6	102 €	112 €	124 €	135 €
500	0,6	104 €	114 €	126 €	138 €
520	0,6	105 €	115 €	129 €	142 €
540	0,7	107 €	117 €	130 €	143 €
570	0,7	113 €	126 €	142 €	158 €
580	0,7				
600	0,7	116 €	130 €	147 €	163 €
620	0,7				
640	0,7	125 €	139 €	158 €	175 €
660	0,7				
680	0,7	128 €	144 €	164 €	183 €
700	0,7				
720	0,7	131 €	169 €	174 €	188 €
750	0,7				
760	0,7	134 €	152 €	173 €	195 €
800	0,8	136 €	166 €	190 €	215 €
820	0,8				
840	0,8				

Pozink. plech (Galvanized steel)						
D (mm)	2 x D (mm)	Hr. (mm)	Výška L:			
			300mm EUR/ks bez DPH	500mm EUR/ks bez DPH	750mm EUR/ks bez DPH	980mm EUR/ks bez DPH
425	850	0,8				
450	900	0,8	141 €	162 €	188 €	213 €
470	940	0,8	146 €	168 €	195 €	221 €
475	950	0,8				
480	960	0,8	147 €	169 €	197 €	224 €
500	1000	0,8	151 €	175 €	204 €	231 €
510	1020	0,8				
530	1060	0,8				
550	1100	0,8				
580	1160	0,8				
625	1250	0,8				
750	1500	0,8				

Pozink. plech (Galvanized steel)					
D + T (mm)	Hr. (mm)	Výška L:			
		300mm EUR/ks bez DPH	500mm EUR/ks bez DPH	750mm EUR/ks bez DPH	980mm EUR/ks bez DPH
850	0,8	137 €	160 €	188 €	216 €
900	0,8	142 €	166 €	198 €	226 €
940	0,8				
950	0,8	148 €	174 €	206 €	235 €
960	0,8				
1000	0,8				
1020	0,8				
1060	0,8	160 €	189 €	226 €	258 €
1100	0,8				
1160	0,8	161 €	203 €	241 €	279 €
1250	0,8	186 €	222 €	267 €	308 €
1500	0,8	233 €	275 €	330 €	381 €

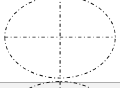
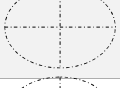
Pozink. plech (Galvanized steel)					
D + T (mm)	Hr. (mm)	Výška L:			
		300mm EUR/ks bez DPH	500mm EUR/ks bez DPH	750mm EUR/ks bez DPH	980mm EUR/ks bez DPH
850	0,8	150 €	171 €	199 €	223 €
900	0,8	155 €	179 €	207 €	233 €
940	0,8				
950	0,8	161 €	186 €	216 €	243 €
960	0,8				
1000	0,8				
1020	0,8	190 €	247 €	252 €	282 €
1060	0,8				
1100	0,8	201 €	231 €	267 €	299 €
1160	0,8				
1250	0,8				
1500	0,8				

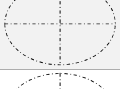
Základné údaje oplechovania (BOXov) pre objednávku:

Por. č.	Plech:	Typ. (F,K,A):	Rozdelenie:	Hrúbka:	D Šírka (mm)	T Hĺbka (mm) (T= A+D/2)	A vzdial. od osi (mm)	L výška (mm) (lem +12mm)	Počet ks:
									
									
									
									
									
									
									

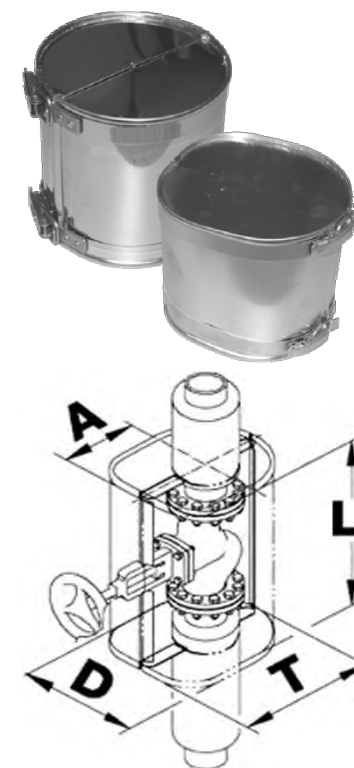

## Oplechovanie EKAMET / OKABELL

### Kryt na príruby

(Flange box)

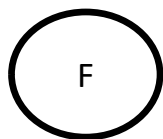

### Kryt jednoduchý

(Case box)

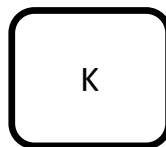

### Kryt na ventil

(Valve box)

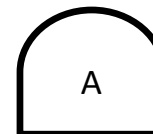

#### Hliník. plech (Aluminum seawater resistant)

D (mm)	2 x D (mm)	Hr. (mm)	Výška L:			
			300mm	500mm	750mm	980mm
			EUR/ks bez DPH	EUR/ks bez DPH	EUR/ks bez DPH	EUR/ks bez DPH
150	300	0,6	75 €	78 €	85 €	104 €
160	320	0,6	76 €	80 €	88 €	108 €
170	340	0,6	78 €	83 €	91 €	112 €
175	350	0,6				
180	360	0,6	79 €	85 €	94 €	117 €
190	380	0,6				
200	400	0,6	84 €	91 €	101 €	126 €
205	410	0,6				
210	420	0,6	86 €	94 €	105 €	130 €
215	430	0,6				
220	440	0,6	88 €	96 €	108 €	138 €
230	460	0,6	90 €	99 €	111 €	143 €
235	470	0,6				
240	480	0,6	92 €	101 €	114 €	147 €
250	500	0,6	94 €	104 €	117 €	152 €
260	520	0,6				
270	540	0,8	109 €	124 €	144 €	162 €
285	570	0,8				
290	580	0,8	115 €	131 €	152 €	172 €
300	600	0,8	117 €	134 €	156 €	176 €
310	620	0,8				
320	640	0,8	123 €	141 €	164 €	186 €
330	660	0,8				
340	680	0,8				
350	700	0,8	132 €	152 €	178 €	201 €
360	720	0,8	134 €	155 €	179 €	205 €
375	750	0,8				
380	760	0,8				
400	800	0,8	147 €	170 €	200 €	227 €
410	820	0,8	149 €	173 €	203 €	231 €
420	840	0,8	151 €	175 €	206 €	235 €

#### Hliník. plech (Aluminum seawater resistant)

D + T (mm)	Hr. (mm)	Výška L:			
		300mm	500mm	750mm	980mm
		EUR/ks bez DPH	EUR/ks bez DPH	EUR/ks bez DPH	EUR/ks bez DPH
300	0,6				
320	0,6	74 €	79 €	89 €	98 €
340	0,6				
350	0,6	77 €	85 €	96 €	106 €
360	0,6				
380	0,6	79 €	88 €	100 €	111 €
400	0,6				
410	0,6	81 €	91 €	104 €	115 €
420	0,6				
430	0,6				
440	0,6	83 €	95 €	108 €	121 €
460	0,6				
470	0,6	86 €	97 €	112 €	126 €
480	0,6				
500	0,6	88 €	100 €	115 €	130 €
520	0,6				
540	0,7	109 €	127 €	149 €	169 €
570	0,7				
580	0,7	113 €	133 €	156 €	179 €
600	0,7				
620	0,7	118 €	139 €	164 €	186 €
640	0,7				
660	0,7	123 €	145 €	171 €	195 €
680	0,7				
700	0,7	127 €	150 €	178 €	204 €
720	0,7				
750	0,7	133 €	157 €	188 €	215 €
760	0,7				
800	0,8	139 €	164 €	196 €	226 €
820	0,8				
840	0,8				

#### Hliník. plech (Aluminum seawater resistant)

D + T (mm)	Hr. (mm)	Výška L:			
		300mm	500mm	750mm	980mm
		EUR/ks bez DPH	EUR/ks bez DPH	EUR/ks bez DPH	EUR/ks bez DPH
300	0,6				
320	0,6				
340	0,6	88 €	95 €	105 €	114 €
350	0,6				
360	0,6				
380	0,6	90 €	99 €	110 €	120 €
400	0,6				
410	0,6	94 €	102 €	114 €	125 €
420	0,6				
430	0,6	95 €	104 €	117 €	128 €
440	0,6				
460	0,6	110 €	120 €	134 €	146 €
470	0,6				
480	0,6	111 €	122 €	136 €	149 €
500	0,6	113 €	126 €	141 €	155 €
520	0,6	114 €	127 €	144 €	158 €
540	0,8	115 €	128 €	146 €	161 €
570	0,8	129 €	144 €	168 €	188 €
580	0,8				
600	0,8	133 €	146 €	174 €	195 €
620	0,8				
640	0,8	143 €	163 €	187 €	208 €
660	0,8				
680	0,8	147 €	168 €	194 €	218 €
700	0,8				
720	0,8	152 €	173 €	200 €	224 €
750	0,8				
760	0,8	155 €	178 €	206 €	231 €
800	0,8	161 €	187 €	218 €	244 €
820	0,8				
840	0,8				

Hliník. plech (Aluminum seawater resistant)						
D (mm)	2 x D (mm)	Hr. (mm)	Výška L:			
			300mm EUR/ks bez DPH	500mm EUR/ks bez DPH	750mm EUR/ks bez DPH	980mm EUR/ks bez DPH
425	850	0,8				
450	900	0,8	160 €	187 €	220 €	250 €
470	940	0,8	166 €	194 €	228 €	260 €
475	950	0,8				
480	960	0,8	168 €	196 €	231 €	264 €
500	1000	0,8	173 €	209 €	239 €	273 €
510	1020	0,8				
530	1060	0,8				
550	1100	0,8				
580	1160	0,8				
625	1250	0,8				
750	1500	0,8				

Hliník. plech (Aluminum seawater resistant)					
D + T (mm)	Hr. (mm)	Výška L:			
		300mm EUR/ks bez DPH	500mm EUR/ks bez DPH	750mm EUR/ks bez DPH	980mm EUR/ks bez DPH
850	0,8	153 €	182 €	215 €	247 €
900	0,8	161 €	189 €	227 €	258 €
940	0,8				
950	0,8	167 €	197 €	236 €	272 €
960	0,8				
1000	0,8				
1020	0,8				
1060	0,8	182 €	217 €	258 €	296 €
1100	0,8				
1160	0,8	194 €	232 €	293 €	320 €
1250	0,8	219 €	264 €	320 €	372 €
1500	0,8	273 €	328 €	397 €	460 €

Hliník. plech (Aluminum seawater resistant)					
D + T (mm)	Hr. (mm)	Výška L:			
		300mm EUR/ks bez DPH	500mm EUR/ks bez DPH	750mm EUR/ks bez DPH	980mm EUR/ks bez DPH
850	0,8	174 €	194 €	226 €	256 €
900	0,8	175 €	202 €	236 €	266 €
940	0,8				
950	0,8	181 €	210 €	244 €	277 €
960	0,8				
1000	0,8				
1020	0,8	214 €	256 €	286 €	323 €
1060	0,8				
1100	0,8	226 €	263 €	304 €	343 €
1160	0,8				
1250	0,8				
1500	0,8				

Základné údaje oplechovania (BOXov) pre objednávku:

Por. č.	Plech:	Typ. (F,K,A):	Rozdelenie:	Hrúbka:	D Šírka (mm)	T Hĺbka (mm) (T= A+D/2)	A vzdial. od osi (mm)	L výška (mm) (lem +12mm)	Počet ks:

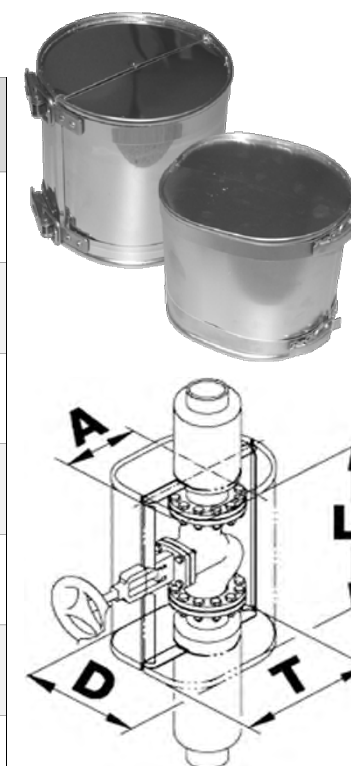

## Oplechovanie- spojovací materiál a príslušenstvo

V ponuke je široký sortiment skrutiek, nitov, praciek a rôznych klampiarskych prvkov potrebných k realizácii oplechovania, vrátane náradia a montážnych pomôcok. Ceny na vyžiadanie.

Skrutka		
Kvalita	Nerez (V2A AISI 304)	Pozink
Variant	Bez podložky	
	Podložka polyamid	
	Podložka EPDM (3x12)	
Priemer	4,2 / 4,8	
Dĺžka	9,5 / 13 / 16 / 19	

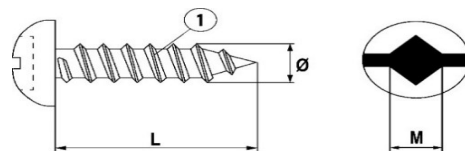

Skrutka samovrtná		
Kvalita	DIN 7504	
	Nerez V2A (AISI 304)	Pozink
Variant	Bez podložky	
	Podložka EPDM (3x12)	
Priemer	4,2 / 4,8	
Dĺžka	13 / 16 / 19	

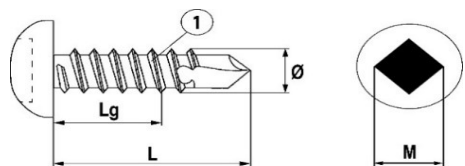

Skrutka		
Kvalita	DIN 7976 (ISO 1479)	
	Nerez V2A+GZ (AISI 304)	Nerez (V2A AISI 304)
Variant	Bez podložky	
	Podložka polyamid	
	Podložka nerez + EPDM	
Priemer	4,2 / 4,8	
Dĺžka	13 / 16 / 19	

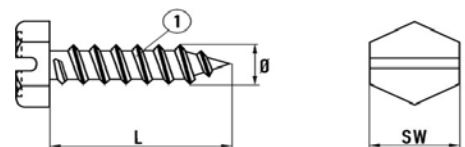

Skrutka samovrtná		
Kvalita	DIN 7504	
	Nerez C1 +GZ (AISI 410)	Pozink
Variant	Bez podložky	
	Podložka nerez + EPDM	
Priemer	4,2 / 4,8	
Dĺžka	13 / 16 / 19	

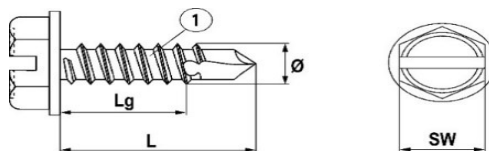

Pracka - patentný uzáver			
Kvalita	Nerez V2A (AISI 304)		
	Pozink		
Variant:	1/60 F	2/55/60 F	4/80 F
Priemer	3,3 / 4,2	3,3 / 4,2	5,00
Šírka, dĺžka	16 x 67	20 x 107	28 x 122

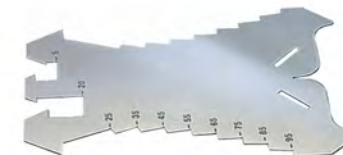



## Povrchy: do vonkajšieho prostredia (náhrada oplechovania)

Náhrada klasického oplechovania. Zloženie fólie zaručuje dobrú mechanickú odolnosť proti pretrhnutiu a prerazeniu. Veľmi vysoká odolnosť proti atmosferickým vplyvom a UV žiareniu. Rýchla a čistá aplikácia.



### Samolepiaca povrchová úprava do vonkajšieho prostredia (fólia kovovej farby)

Položka	Popis	MJ	EUR/MJ bez DPH	EUR/bal. bez DPH
Anticor CLAD 155 0,6 x 50m	samolepiaci, kovovo hladký UV odolný laminovaný AL povrch	m2	<b>9,70 €</b>	<b>291 €</b>
Anticor CLAD 155 páska 50mm x 50m	samolepiaci, kovovo hladký UV odolný laminovaný AL povrch	ks	<b>27,00 €</b>	-
Anticor CLAD 155 páska 75mm x 50m	samolepiaci, kovovo hladký UV odolný laminovaný AL povrch	ks	<b>40,50 €</b>	-
Anticor CLAD 155 páska 100mm x 50m	samolepiaci, kovovo hladký UV odolný laminovaný AL povrch	ks	<b>54,00 €</b>	-
Anticor CLAD 155 0,6 x 50m	samolepiaci, kovovo štrukturovaný UV odolný laminovaný AL povrch	m2	<b>10,80 €</b>	<b>324 €</b>
Anticor CLAD 155 páska 50mmx 50m	samolepiaci, kovovo štrukturovaný UV odolný laminovaný AL povrch	ks	<b>30,40 €</b>	-



### Samolepiaca povrchová úprava do vonkajšieho prostredia (fólia kovovej farby)

Položka	Popis	MJ	EUR/MJ bez DPH	EUR/bal. bez DPH
Tembutil IF (hr.1,0 mm) 1 x 15m	kovovo matný UV odolný povrch + samolepiaca butylová parozábrana	m2	<b>16,00 €</b>	<b>240 €</b>

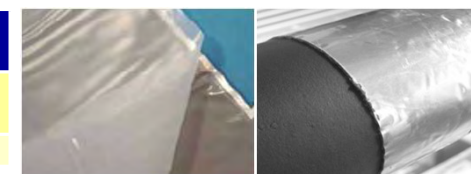

### Povrchová úprava do vonkajšieho prostredia (fólia kovovej farby na drôtenom pletive)

Položka	Popis	MJ	EUR/MJ bez DPH	EUR/bal. bez DPH
FLEXIPANE kamenná 1 x 50m	fólia kovovo lesklej farby na pomedenom štvorhrannom pletive- oko:12mm	m2	<b>6,00 €</b>	<b>300 €</b>
FLEXIPANE 16 1 x 50m	fólia kovovo lesklej farby na šesťhrannom pozinkovanom pletive- oko:16mm	m2	<b>7,00 €</b>	<b>175 €</b>
FLEXIPANE 25 1 x 50m	fólia kovovo lesklej farby na šesťhrannom pozinkovanom pletive- oko:25mm	m2	<b>6,00 €</b>	<b>150 €</b>



## ARMACELL príslušenstvo

Položka:	Popis:	Rozmery:	ks/ bal.	EUR/ks bez DPH
Lepidlo Ultima 700 1l	Adhesive Ultima AHU-700/1,0	1,0 l	12	<b>71,30 €</b>
Lepidlo Ultima RS 850 0,8l	Adhesive Ultima AHU-RS 850/0,7l	0,8 l	6	<b>68,40 €</b>
Lepidlo Ultima SF990 0,8l	Adhesive Ultima AHU-SF990/0,8	0,8 l	12	<b>83,20 €</b>
Ultima páska 50	UD-TAPE	15m - 50x3mm	12	<b>124,20 €</b>
				<b>- €</b>
Lepidlo Armaflex 520 0,25l so štetcom	Adhesive Armaflex ADH-520/0,25E	0,25 l	24	<b>16,90 €</b>
Lepidlo Armaflex 520 0,5l	Adhesive Armaflex ADH-520/0,5E (420g)	0,5 l	12	<b>20,20 €</b>
Lepidlo Armaflex 520 1l	Adhesive Armaflex ADH-520/1,0E (840g)	1,0 l	12	<b>36,40 €</b>
Lepidlo Armaflex 520 2,5l	Adhesive Armaflex ADH-520/2,5E(2100g)	2,5 l	8	<b>65,40 €</b>
Armaflex AF páska 50	AF-TAPE B1	50x3mm x 15m	12	<b>60,00 €</b>
Armaflex AC páska 50	AC-TAPE/50	50x3mm x 15m	12	<b>27,50 €</b>
Armaflex NH páska 50	NH-TAPE	50x3mm x 15m	12	<b>75,60 €</b>
				<b>- €</b>
Čistič na lepidlo Armaflex 520 a 625 1l	Cleaner for adhesive 520/625 CLEANER/1,0	1,0 l	4	<b>19,60 €</b>
				<b>- €</b>
Lepidlo HT/Armaflex 625 0,25l	Adhesive Armaflex ADH-HT625/0,25	0,25 l	40	<b>27,20 €</b>
Lepidlo HT/Armaflex 625 0,5l	Adhesive Armaflex ADH-HT625/0,5 (420g)	0,5 l	12	<b>30,50 €</b>
Lepidlo HT/Armaflex 625 1l	Adhesive Armaflex ADH-HT625/1,0 (840g)	1,0 l	12	<b>47,40 €</b>
Armaflex HT páska 50	HT-TAPE	50x3mm x 15m	12	<b>75,60 €</b>
Armaflex HT S páska PE biela	Tape FE 902	50x0,08mm x 25m	30	<b>44,50 €</b>
Armaflex HT S páska PE čierna	Tape FE 904	50x0,08mm x 25m	30	<b>44,50 €</b>
				<b>- €</b>
Armacomfort páska PE čierna	Tape FE 904	50x0,08mm x 25m	30	<b>44,50 €</b>
Arma-Chek SILVER páska 30	ACH-PSATAPES-30	30mm x 50m	1	<b>26,10 €</b>
Arma-Chek SILVER páska 50	ACH-PSATAPES-50	50mm x 50m	1	<b>63,00 €</b>
				<b>- €</b>
Farba Armafinish (biela farba RAL 9001) 2,5l	Armafinish 99 cream white FINISH/WH-2,5 (3kg)	2,5 l	4	<b>118,90 €</b>
Farba Armafinish (šedá farba RAL 7037) 2,5l	Armafinish 99 silver grey FINISH/GY-2,5 (3kg)	2,5 l	4	<b>118,90 €</b>
				<b>- €</b>
Štetec s mechanickým dávkovačom	Glumaster (pump) 0,25 Litre	1 ks	-	<b>71,90 €</b>
Náhradný štetec 11 mm	Glumaster-Brush 11 mm	1 ks	-	<b>15,40 €</b>
Náhradný štetec 17 mm	Glumaster-Brush 17 mm	1 ks	-	<b>17,50 €</b>
Keramický nôž	CERAMIC-KNIFE	1 ks	-	<b>68,20 €</b>
				<b>- €</b>
Tubolit páska TL 50 (šedá)	TL-TAPE/50-DG	50x3mm x 10m	12	<b>21,90 €</b>
Tubolit páska AR 50 (modrá)	TL-TAPE/50-AR	50x3mm x 15m	12	<b>41,40 €</b>
Tubolit páska AR 100 (modrá)	TL-TAPE/100-AR	100x3mm x 15m	6	<b>62,00 €</b>
Tubolit páska AR FONOWAVE 50 (modrá)	TL-TAPE/50-ARW	50x3mm x 15m	12	<b>47,40 €</b>
				<b>- €</b>
Spony na Tubolit	TL-CLIPS	1 ks	100	<b>0,02 €</b>



## KAIMANN príslušenstvo

Položka:	Popis:	Rozmery:	ks/ bal.	EUR/ks bez DPH
Kaiflex 414 lepidlo 0,26l so štetcom	Kaiflex 414 adhesive 0,26l (220g)	0,26 l	20	<b>10,00 €</b>
Kaiflex 414 lepidlo 0,79l	Kaiflex 414 adhesive 0,79l (660g)	0,79 l	20	<b>18,50 €</b>
Kaiflex 414 lepidlo 2,6l	Kaiflex 414 adhesive 2,6l (2200g)	2,6 l	6	<b>49,00 €</b>
Kaiflex 494 lepidlo	Kaiflex 494 "LEED" 2300g	2300g	6	<b>91,30 €</b>
ST páska 50	ST tape - self adhesive	15m - 50x3mm	12	<b>15,00 €</b>
EF páska 50	EF tape - self adhesive	15m - 50x3mm	12	<b>13,50 €</b>
				<b>- €</b>
Kaiflex - špec. čistiadlo 1l	Special cleaner	1l	12	<b>14,70 €</b>
				<b>- €</b>
EPDM lepidlo 0,79l	Solar EPDM adhesive	660g	20	<b>35,20 €</b>
EPDM páska 50	Solar EPDM tape -self adhesive	15m - 50x3mm	12	<b>45,50 €</b>
				<b>- €</b>
ALU TEC samolepiaci povlak	ALU TEC pre covered	25m -1000mm	1	<b>26,90 €</b>
ALU TEC páska 50	ALU TEC tape	50m - 50mm	24	<b>49,00 €</b>
ALU TEC butyl páska 50	ALU TEC butyl tape	25m -50mm	12	<b>33,00 €</b>
				<b>- €</b>
Kaiflex - Finish (biela farba)	Kaifinish protective coating pure white RAL 9010	0,75l	12	<b>36,80 €</b>
Kaiflex - Finish (šedá farba)	Kaifinish protective coating grey RAL 7035	0,75l	12	<b>- €</b>
				<b>- €</b>
Štetec s mechanickým dávkovačom	Adhesive pump +17mm paintbrush	1 ks	-	<b>73,10 €</b>
Náhradný štetec 11 mm	Paintbrush 11 mm	1 ks	-	<b>18,40 €</b>
Náhradný štetec 17 mm	Paintbrush 17 mm	1 ks	-	<b>19,90 €</b>
Sada nožov	kaiflex set of knives (3 knives, 1 grinding stone)	1 ks	-	<b>28,90 €</b>
Keramický nôž	Ceramic cutter 12cm	1 ks	-	<b>39,30 €</b>
Nôž pre rezanie pásov	Knife	1 ks	-	<b>28,20 €</b>



## AZ FLEX príslušenstvo

Položka:	Popis:	ks/ bal.	EUR/ks bez DPH
Rezacia šablóna - malá	Vnútorne rozmery (d x š x v) 400 x 105 x 110mm	1	<b>24 €</b>
Rezacia šablóna - veľká	Vnútorne rozmery (d x š x v) 680 x 200 x 210mm	1	<b>52 €</b>
Rezacia šablóna - rozoberateľná	Vonkajšie rozmery (d x š x v) 430 x 450 x 350mm	1	<b>66 €</b>
Nôž dlhý rovný	Ostrie noža s dĺžkou 250 až 350 mm	1	<b>14 €</b>
Nôž dlhý zubatý	Ostrie noža s dĺžkou 300 mm	1	<b>14 €</b>
Nožnice na rohože s pletivom	Ostrie noža s dĺžkou 250mm	1	<b>104 €</b>
Viazací drôt 0,6mm	Pozinkovaný drôt 0,65mm x 30m - 0,1kg	25	<b>1 €</b>
Háčik na rohože s pletivom 95mm	Blanket hooks, steel zinc plated, diameter 2 mm, length 95 mm	1000	<b>0,025 €</b>
Háčik na rohože s pletivom 115mm	Blanket hooks, steel zinc plated, diameter 2 mm, length 115 mm	1000	<b>0,030 €</b>
Stabil páska 10m x 40mm	Samolepiaca páska červenej, modrej alebo bielej farby 10m x 40mm	1	<b>7 €</b>
Lepidlo Mirelon-Therm 0,1l	Tuba 100ml 0,1l	1	<b>4 €</b>
Lepidlo Mirelon-Therm 0,5l	Plechovka 500 ml 0,5l	1	<b>8 €</b>
Izoflex P2 4/25 PE páska 40mm x 25m	25m - 2x40mm 25m x 40mm	1	<b>8 €</b>
Izoflex P2 4/25 PE páska 40mm x 10m	10m - 2x40mm	1	<b>4 €</b>
Power Spray lepidlo 500ml	Aerosolové lepidlo na lepenie vláknitých izolácií, spotreba cca 5m <sup>2</sup>	1	<b>8 €</b>



### Navarovacie trne Ø 2,7mm s klobučíkom Ø 30mm

Položka:	Třne na priváranie kondenzátorovým výbojom tzv. hrotovým zapáľovaním pre izoláciu s AL polepom hr. (mm):	Variant DE	Variant CZ	ks/bal.	EUR/ks bez DPH
Navarovací trň - izolovaný 19mm	20	x	x	500	0,12 €
Navarovací trň - izolovaný 25,4mm	25	x	x	500	0,13 €
Navarovací trň - izolovaný 28mm	30	x	x	500	0,13 €
Navarovací trň - izolovaný 31,7mm	30	x	x	500	0,14 €
Navarovací trň - izolovaný 38mm	40	x	x	500	0,14 €
Navarovací trň - izolovaný 47,6mm	50	x	x	500	0,15 €
Navarovací trň - izolovaný 54mm	60	x	x	500	0,17 €
Navarovací trň - izolovaný 57,2mm (58mm)	60	x	x	500	0,17 €
Navarovací trň - izolovaný 60,5mm	60	x	x	500	0,17 €
Navarovací trň - izolovaný 63,5mm (64mm)	60	x	x	500	0,18 €
Navarovací trň - izolovaný 76mm	80	x	x	500	0,19 €
Navarovací trň - izolovaný 78mm	80	x	x	500	0,19 €
Navarovací trň - izolovaný 98mm	100	x	x	500	0,20 €
Navarovací trň - izolovaný 139mm	140		x	500	0,37 €
Navarovací trň - izolovaný 152,4mm	150		x	500	0,37 €



### Navarovacie trne

Položka:	Popis:	ks/ bal.	EUR/ks bez DPH
Samosvorná podložka Ø 30mm	Pre třne Ø 2mm	1000	0,04 €
Samosvorná podložka Ø 38mm	Pre třne Ø 2mm	1000	0,05 €
Samosvorná podložka nerez Ø 30mm	Pre třne Ø 2mm	1000	0,20 €
Samosvorná podložka nerez Ø 38mm	Pre třne Ø 2mm	1000	0,24 €
Navarovací trň Ø 2mm x 105mm	Oceľový trň (pomednený) na priváranie kondenzátorovým výbojom.	1000	0,05 €



### Navarovacie agregáty

Položka:	Popis:	ks/ bal.	EUR/ks bez DPH
Navarovací agregát LBS 075	66 000 µF, Ø 2-8mm, až 20ks/min., rozmery 195x265x410, 11kg	ks	3 250 €
Navarovací agregát LBS 044	44.000 µF, Ø 2-6mm, až 20ks/min., rozmery 195x260x400, 10kg	ks	2 950 €
Navarovací agregát ISOFIX	88.000 µF, Ø 2-3mm, až 30ks/min., rozmery 195x320x270, 7kg	ks	2 500 €
Navarovací agregát ISOFIX accu	88.000 µF, Ø 2-3mm, až 20ks/min., rozmery 195x202x270, 9kg	ks	3 200 €
Magnetická klieština kompl.	Magnet + plastový kryt	ks	148 €
Náhradný magnet	Magnet	ks	90 €
Prenájom navarovacieho agregátu	1 deň, rozmery 195x260x400, 10kg	deň	35 €



### Samolepiace AL pásy

Položka:	Popis:	EUR/bm bez DPH	EUR/ks bez DPH
Páska ALU 302 48mm x 50m x 0,060mm (24)	Preložka zo silikónového papiera, akrylátové lepidlo, pevnosť v ťahu 45N/25mm, lepiivosť k oceli 15N/25mm.	0,120 €	<b>6,00 €</b>
Páska ALU 302 75mm x 50m x 0,060mm (16)		0,200 €	<b>10,00 €</b>
Páska ALU 302 100mm x 50m x 0,060mm (12)		0,260 €	<b>13,00 €</b>
Páska ALU 302/1 50mm x 100m x 0,060mm (24)	Preložka z PE fólie, akrylátové lepidlo, pevnosť v ťahu 45N/25mm, lepiivosť k oceli 15N/25mm. Opačné radenie vrstiev	0,100 €	<b>10,00 €</b>
Páska ALU 302/1 75mm x 100m x 0,060mm (16)		0,150 €	<b>15,00 €</b>
Páska ALU 302/1 100mm x 100m x 0,060mm (12)		0,200 €	<b>20,00 €</b>
Páska ALU 352-353 + mriežka 48mm x 50m x 0,083mm (24)	Preložka zo silikónového papiera, akrylátové lepidlo, pevnosť v ťahu 100N/25mm, lepiivosť k oceli 15N/25mm.	0,220 €	<b>11,00 €</b>
Páska ALU 352-353 + mriežka 75mm x 50m x 0,083mm (16)		0,330 €	<b>16,50 €</b>
Páska ALU 352-353 + mriežka 100mm x 50m x 0,083mm (12)		0,440 €	<b>22,00 €</b>
Páska ALU 371 50m x 48mm x 0,060mm (24) bez preložky	použitie do 100°C, bez preložky	0,170 €	<b>8,50 €</b>
Páska ALU 306 BLACK 50mm x 100m x 0,060mm (24)	Preložka zo silikónového papiera, akrylátové lepidlo,	0,140 €	<b>14,00 €</b>
Páska ALU 306 BLACK 75mm x 100m x 0,060mm (16)		0,210 €	<b>21,00 €</b>
Páska ALU 306 BLACK 100mm x 100m x 0,060mm (12)		0,280 €	<b>28,00 €</b>



### Samolepiace BOPP / PE pásy

Položka:	Popis:	EUR/bm bez DPH	EUR/ks bez DPH
Páska BOPP 341 pokovená 50m x 50mm x 0,030mm (96)	Pevnosť v ťahu 120N/25mm, lepiivosť 5N/25mm.	0,066 €	<b>3,30 €</b>
Páska PVC 111 Polytex šedá + textilná mriežka 25mm x 38mm x	Pevnosť v ťahu 90N/25mm, lepiivosť k oceli 20N/25mm.	0,148 €	<b>3,70 €</b>



### Výstražné pásy / fólie

Položka:	Popis:	EUR/bm bez DPH	EUR/ks bez DPH
Fólia červeno/biela	výstražná fólia 100m x 80mm	0,040 €	<b>4,00 €</b>
Fólia žltá- potlač POZOR PLYN	výstražná fólia 100m x 300mm	0,150 €	<b>15,00 €</b>
Fólia biela - potlač POZOR VODA	výstražná fólia 100m x 300mm	0,135 €	<b>13,50 €</b>
Fólia modrá - potlač POZOR VODA	výstražná fólia 100m x 300mm	0,135 €	<b>13,50 €</b>
Fólia modrá	výstražná fólia 100m x 300mm	0,135 €	<b>13,50 €</b>
Fólia oranžová	výstražná fólia 100m x 300mm	0,135 €	<b>13,50 €</b>
Fólia zelená	výstražná fólia 100m x 300mm	0,135 €	<b>13,50 €</b>
Fólia hnedá	výstražná fólia 100m x 300mm	0,135 €	<b>13,50 €</b>



### Samolepiace AL pásy

Položka:	Popis:	EUR/bm bez DPH	EUR/ks bez DPH
Páska ALU P01G 50mm x 50m x 0,070mm (24)	Preložka zo silikónového papiera, akrylátové lepidlo, pevnosť v ťahu 20N/25mm, lepivosť 15N/25mm.	0,136 €	<b>6,80 €</b>
Páska ALU P01G 75mm x 50m x 0,070mm (16)		0,200 €	<b>10,00 €</b>
Páska ALU P01G 100mm x 50m x 0,070mm (12)		0,260 €	<b>13,00 €</b>
Páska ALU P01F 50mm x 100m x 0,065mm (24)	Preložka z PE fólie, polyakrylátové lepidlo, pevnosť v ťahu 30N/25mm, lepivosť 15N/25mm. Opačné radenie vrstiev.	0,155 €	<b>15,50 €</b>
Páska ALU P01F 75mm x 100m x 0,065mm (16)		0,235 €	<b>23,50 €</b>
Páska ALU P01F 100mm x 100m x 0,065mm (12)		0,310 €	<b>31,00 €</b>
Páska ALU P01C + mriežka 50mm x 45m x 0,090mm (24)	Preložka z PP fólie, modifikované akrylátové lepidlo, pevnosť v ťahu 12N/25mm, lepivosť 15N/25mm.	0,244 €	<b>11,00 €</b>
Páska ALU P01C + mriežka 100mm x 45m x 0,090m (12)		0,489 €	<b>22,00 €</b>



### Samolepiace BOPP/PE pásy

Položka:	Popis:	EUR/bm bez DPH	EUR/ks bez DPH
Páska BOPP P02 pokovená 50mm x 50m x 0,050mm (36)	Pevnosť v ťahu 100N/25mm, lepivosť 5N/25mm.	0,044 €	<b>2,20 €</b>
Páska PVC P16 šedá 38mm x 33m x 0,130mm (60)	Akrylátové lepidlo, pevnosť v ťahu 25N/25mm, lepivosť 1,5N/25mm.	0,106 €	<b>3,50 €</b>
Páska PVC P16 šedá 50mm x 33m x 0,130mm (48)		0,136 €	<b>4,50 €</b>



### Samolepiace AL butylové pásy

Položka:	Popis:	EUR/bm bez DPH	EUR/ks bez DPH
Páska ALU S06 butylová 50mm x 10m x 1mm (12)	Páska s adhéznym butylkaučukovým lepidlom, pevnosť v ťahu 60N/25mm.	1,150 €	<b>11,50 €</b>
Páska ALU S06 butylová 75mm x 10m x 1mm (9)		1,700 €	<b>17,00 €</b>
Páska ALU S06 butylová 100mm x 10m x 1mm (6)		2,300 €	<b>23,00 €</b>



### Penetračné postreky na likvidáciu AZC materiálov

Položka:	Popis:	ks/ bal.	EUR/ks bez DPH
Foster® 32-60 25 l	Spotreba: 5 až 7,5m <sup>2</sup> /liter, riedenie možné až do pomeru 1:4.	1	<b>172 €</b>



### Striekaná PUR pena

Položka:	Popis:	MJ	EUR/MJ bez DPH
Handi-Foam II-605 (A+B) 2x20kg	QR alebo SR (30kg/m <sup>3</sup> ), výdatnosť 1,2 až 1,4 m <sup>3</sup>	1 set	<b>1 160 €</b>
Set obsahuje: 1ks nádobu so zložkou A a 1ks nádoby so zložkou B.			







Položka:	Popis:	MJ	EUR/MJ bez DPH
Standart GHA-15	set: pištoľ + hadice 4,6m + trysky 10ks	1 set	<b>150 €</b>
Aplikačná tryska	sprejovacia alebo injektážna	ks	<b>2 €</b>

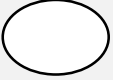
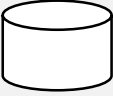

## Tabuľka rozmerov potrubí a ich vonkajších priemerov

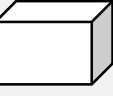
Medené potrubie:		PPR/ PVC potrubie: vonk. Ø (mm)	Oceľové potrubie:			Vonk. Ø potrubia
vnútorný Ø DN (mm)	Coul		vnútorný Ø DN (mm)	Coul	vonk. Ø (mm)	
4	1/4				→ 6	
6					→ 8	
8	3/8		6	1/8	→ 10	
10	1/2				→ 12	
12	5/8	14	8	1/4	→ 15	
			10	3/8	→ 18	
		20			→ 20	
20	7/8		15	1/2	→ 22	
		25			→ 25	
25	1 1/8		20	3/4	→ 28	
				30	→ 30	
		32			→ 32	
32	1 3/8		25	1	→ 35	
		40			→ 40	
40	1 5/8		32	1 1/4	→ 42	
					→ 45	
			40	1 1/2	→ 48	
		50			→ 50	
50	2 1/8				→ 54	
					→ 57	
			50	2,0	→ 60	
60		63			→ 64	
	2 3/4				→ 70	
72	3	75	65	2 1/2	→ 76	
	3 1/8				→ 80	
85		90	80	3	→ 89	
				3 1/2	→ 102	
103	4 1/4	110	100		→ 110	
			100	4	→ 114	
		125			→ 125	
127			125,0		→ 133	
			125	5	→ 140	
153			150,0		→ 160	
			150,0	6	→ 168	
		200			→ 204	
213			200		→ 219	
		250			→ 254	
			250		→ 273	
			300,0		→ 324	
			350,0		→ 377	
			400,0		→ 457	

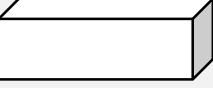
Matematika		
obvod kruhu	$O=2 \cdot \pi \cdot r$ alebo $O=\pi \cdot d$	
obsah kruhu	$S=\pi \cdot r^2$	
povrch valca	$S=2 \cdot \pi \cdot r \cdot (v+r)$ alebo $S=\pi \cdot d \cdot (v+r)$	
objem valca	$V=\pi \cdot r^2 \cdot v$	
obvod štvorca	$O=4 \cdot a$	
obsah štvorca	$S=a \cdot a$	
povrch kocky	$S=6 \cdot a \cdot a$	
objem kocky	$V=a \cdot a \cdot a$	
obvod obdĺžnika	$O=2 \cdot a + 2 \cdot b$	
obsah obdĺžnika	$S=a \cdot b$	
povrch kvádra	$S=2 \cdot (a \cdot b + a \cdot c + b \cdot c)$	
objem kvádra	$V=a \cdot b \cdot c$	

### Výpočet dĺžky lamelovej rohože pre potrubie (napr. VZT):

Kruhové potrubie	$L=(d+2 \cdot t) \cdot \pi$
Pravouhlé potrubie	$L=2 \cdot a+2 \cdot b+8 \cdot t$

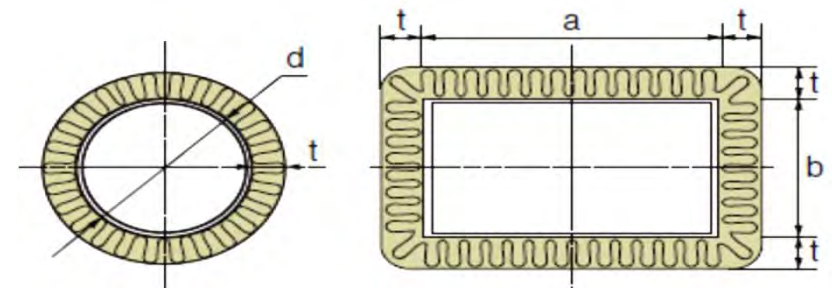

## Tabuľky spotreby pre izolácie zo syntetického kaučuku (Armaflex, Kaiflex a pod.)

### Spotreba lepidla (trubicová izolácia)

Hrúbka izolácie (mm):	10	20	30	40
Pozdĺžne nerozrezaná trubicová izolácia	1120 m/l	280 m/l	175 m/l	130 m/l
Pozdĺžne rozrezaná trubicová izolácia	140 m/l	70 m/l	45 m/l	35 m/l

### Spotreba lepidla (plošná izolácia):

Hrúbka izolácie (mm):	10	20	30	40
Doskový materiál (pásy)	3 - 4 m <sup>2</sup> z 1 litra			

### Množstvo m2 plošnej izolácie potrebnej k zaizolovaniu armatúry (hr. izol 9 až 32mm)

Priemer potrubia (mm):	90° ohyb	45° ohyb	T-Kus	Ventil	Rovný kus:	Príruba
89	0,15	0,13	0,09	0,40	0,44	0,21
114	0,21	0,18	0,10	0,51	0,52	0,29
140	0,29	0,24	0,12	0,72	0,60	0,35
169	0,38	0,32	0,14	0,93	0,69	0,40
219	0,57	0,47	0,21	1,10	0,84	0,55
273	0,83	0,69	0,26	1,40	1,02	0,79
324	1,11	0,93	0,40	1,80	1,18	0,97
356	1,30	1,09	0,43	2,31	1,28	1,17
406	1,65	1,38	0,48	2,90	1,43	1,42
457	2,05	1,71	0,54	3,60	1,60	1,70
508	2,46	2,05	0,59	4,40	1,75	2,05

### Pracovný čas (v minútach), potrebný na narezanie a zalepenie izolácie (normovaná spotreba pri montáži do výšky 2m)

Priemer potrubia (mm):	90° ohyb	45° ohyb	T-Kus	Ventil	Rovný kus (1m)	Príruba	Kryt tvaru D	Redukcia
12	3	3	3	5	6	10		3
25	3	3	3	5	6	10		3
32	3	3	3	5	6	10		3
40	3	3	3	5	6	10		3
50	4	4	4	15	6	10	10	5
65	4	5	5	20	6	15	15	6
80	8	4	4	20	8	15	15	46
100	10	5	5	30	9	20	20	10
150	15	8	8	40	12	25	30	15
200	20	10	10	50	15	30	40	20

čas vypočítaný pre plošnú izoláciu.

### Izolačné pásy a ich použitie na potrubiach

Priemer potrubia (mm):	Hrúbka izolácie (mm):					
	9	13	19	25	32	50
od ø 89	áno	áno				
od ø 114	áno	áno	áno			
od ø 160	áno	áno	áno	áno		
od ø 250	áno	áno	áno	áno	áno	
od ø 600	áno	áno	áno	áno	áno	áno

### Počet kusov armatúr, ktoré je možné urobiť z 1 metra potrubnej izolácie

Priemer potrubia (mm):	90° ohyb	45° ohyb	2+1 segment. koleno	2+2 segment. koleno	T-Kus	Redukcia
15	5	7	5	4	10	10
22	5	7	5	4	10	10
28	5	7	5	4	10	10
35	5	7	5	4	10	10
42	5	6	5	4	10	10
48	5	6	5	4	7	7
60	4	6	4	3	7	7
76	4	6	4	3	5	5
89	4	5	4	3	5	5
114	3	5	3	2	5	5

### Spotreba ochranej farby Armafinish alebo Kaifinish (v litroch), počítaná pri dvoch vrstvách náteru (cca 4 m<sup>2</sup>/1 liter)

Vonkajší priemer na izolácii (mm):	Dĺžka potrubia (m)			
	1	10	50	100
60	0,1	1,0	5,2	10,4
80	0,1	1,4	6,9	13,8
100	0,2	1,7	8,6	17,3
120	0,2	2,1	10,4	20,7
140	0,2	2,4	12,1	24,2
160	0,3	2,8	13,8	27,6
180	0,3	3,1	15,5	31,1
200	0,3	3,5	17,3	34,5
225	0,4	3,9	19,4	38,9
250	0,4	4,3	21,6	43,2
300	0,5	5,2	25,9	51,8
400	0,7	6,9	34,5	69,1

**Priemerná spotreba množstva (metrov) pásky, počítaná pri prelepovaní všetkých lepených spojov (pričných aj pozdĺžnych) 1 metra izolácie hrúbky 13, 19 a 25 mm**

Priemer potrubia (mm):	Rozrezaná izolácia (1m)			Nerozrezaná izolácia (1m) alebo T-Kus (1ks)			90°koleno 2+1 segment (1ks)			90°koleno 2+2 segmenty (1ks)			90°koleno 2+3 segmenty (1ks)		
	13	19	25	13	19	25	13	19	25	13	19	25	13	19	25
10	1,24	1,28	1,32	0,14	0,18	0,22	0,25	0,34	0,41	0,38	0,50	0,60	0,50	0,67	0,81
12	1,25	1,29	1,32	0,15	0,19	0,22	0,27	0,35	0,42	0,40	0,52	0,62	0,53	0,70	0,84
15	1,26	1,30	1,33	0,16	0,20	0,23	0,29	0,37	0,44	0,43	0,55	0,66	0,57	0,76	0,91
20	1,27	1,31	1,35	0,17	0,21	0,25	0,32	0,40	0,47	0,48	0,61	0,72	0,64	0,80	0,94
22	1,28	1,32	1,36	0,18	0,22	0,26	0,34	0,42	0,49	0,50	0,63	0,74	0,67	0,84	0,98
28	1,30	1,34	1,38	0,20	0,24	0,28	0,38	0,46	0,53	0,56	0,69	0,80	0,75	0,92	1,07
35	1,32	1,36	1,40	0,22	0,26	0,30	0,43	0,51	0,58	0,64	0,76	0,87	0,85	1,04	1,19
42	1,34	1,38	1,42	0,24	0,28	0,32	0,47	0,56	0,64	0,71	0,83	0,94	0,94	1,12	1,27
48	1,36	1,40	1,44	0,26	0,30	0,34	0,52	0,60	0,68	0,77	0,90	1,01	1,03	1,20	1,35
60	1,40	1,44	1,48	0,30	0,34	0,38	0,60	0,68	0,76	0,90	1,02	1,13	1,19	1,36	1,51
76	1,45	1,49	1,53	0,35	0,39	0,43	0,70	0,78	0,85	1,03	1,14	1,25	1,40	1,55	1,70
89	1,49	1,53	1,57	0,39	0,43	0,47	0,78	0,86	0,93	1,15	1,26	1,37	1,57	1,72	1,87
114	1,57	1,61	1,65	0,47	0,51	0,55	0,94	1,02	1,09	1,38	1,49	1,60	1,88	2,03	2,18
133	1,63	1,67	1,70	0,53	0,57	0,60	1,06	1,13	1,21	1,56	1,67	1,78	2,12	2,27	2,42
159	1,71	1,75	1,79	0,61	0,65	0,69	1,22	1,30	1,37	1,80	1,91	2,02	2,44	2,60	2,75
219	1,90	1,94	1,98	0,80	0,84	0,88	1,60	1,67	1,75	2,35	2,46	2,57	3,20	3,35	3,50

**Priemerná spotreba množstva (metrov) pásky pri prelepovaní priečného spoja izolácie**

Priemer potrubia (mm):	Hrúbka izolácie (mm):							
	20	25	30	40	50	60	80	100
76	0,39	0,43	0,46	0,51	0,57	0,63	0,73	0,85
89	0,43	0,47	0,50	0,56	0,61	0,68	0,77	0,90
114	0,51	0,55	0,58	0,63	0,69	0,75	0,85	0,97
133	0,57	0,61	0,64	0,69	0,75	0,81	0,91	1,03
160	0,66	0,69	0,73	0,78	0,84	0,90	0,99	1,12
219	0,84	0,88	0,91	0,96	1,02	1,08	1,18	1,30

**Spotreba spôn pri polyetylénových potrubných izoláciách**

Spony (céčka) **cca 5 ks na 1bm**

**Spotreba navarovacích trňov**

Navarovací trň **11-20 ks na 1m<sup>2</sup>**

**Počet m<sup>2</sup> v m<sup>3</sup>**

Množstvo (m2) izolácie v objeme:	Hrúbka plošnej izolácie:														
	9	13	20	25	30	40	50	60	70	80	90	100	120	140	200
m2 v 1 m3	111	76,9	50,0	40,0	33,3	25,0	20,0	16,7	14,3	12,5	11,1	10,0	8,3	7,1	5,0
m2 v 5 m3	556	385	250	200	167	125	100	83,3	71,4	62,5	55,6	50,0	41,7	35,7	25,0
m2 v 15 m3	1667	1154	750	600	500	375	300	250	214	188	167	150	125	107	75,0
m2 v 40 m3	4444	3077	2000	1600	1333	1000	800	667	571	500	444	400	333	286	200
m2 v 90 m3	10000	6923	4500	3600	3000	2250	1800	1500	1286	1125	1000	900	750	643	450

**Orientačná spotreba pásov (m2) potrebných na zaizolovanie 1bm potrubia resp. tabuľky vonkajších obvodov (na izolácii)**

Vonkajší ø potr. (mm)	Dĺžka prírezu (obvodu "m") pre hrúbku izolácie (mm):												
	9 mm	13 mm	20 mm	25 mm	30 mm	40 mm	50 mm	60 mm	80 mm	100 mm	101 mm	150 mm	200 mm
	12		0,123	0,168	0,201	0,233	0,30	0,36	0,43	0,56	0,69	0,69	1,01
15		0,133	0,178	0,210	0,243	0,31	0,37	0,44	0,57	0,70	0,70	1,02	1,34
18		0,142	0,188	0,220	0,252	0,32	0,38	0,45	0,58	0,71	0,71	1,03	1,35
20		0,149	0,194	0,226	0,259	0,32	0,39	0,45	0,58	0,71	0,72	1,03	1,36
22	0,129	0,155	0,201	0,233	0,265	0,33	0,39	0,46	0,59	0,72	0,72	1,04	1,36
25	0,139	0,165	0,210	0,243	0,275	0,34	0,40	0,47	0,60	0,73	0,73	1,05	1,37
28	0,149	0,175	0,220	0,252	0,285	0,35	0,41	0,48	0,61	0,74	0,74	1,06	1,38
30	0,155	0,181	0,226	0,259	0,291	0,36	0,42	0,49	0,61	0,74	0,75	1,07	1,39
32	0,162	0,188	0,233	0,265	0,298	0,36	0,43	0,49	0,62	0,75	0,76	1,07	1,40
35	0,171	0,197	0,243	0,275	0,31	0,37	0,44	0,50	0,63	0,76	0,77	1,08	1,41
38	0,181	0,207	0,252	0,285	0,32	0,38	0,45	0,51	0,64	0,77	0,78	1,09	1,42
42	0,194	0,220	0,265	0,298	0,33	0,39	0,46	0,52	0,65	0,78	0,79	1,11	1,43
45	0,204	0,230	0,275	0,31	0,34	0,40	0,47	0,53	0,66	0,79	0,80	1,12	1,44
48	0,213	0,239	0,285	0,32	0,35	0,41	0,48	0,54	0,67	0,80	0,81	1,13	1,45
50	0,220	0,246	0,291	0,32	0,36	0,42	0,49	0,55	0,68	0,81	0,82	1,13	1,46
54	0,233	0,259	0,30	0,34	0,37	0,43	0,50	0,56	0,69	0,82	0,83	1,14	1,47
57	0,243	0,268	0,31	0,35	0,38	0,44	0,51	0,57	0,70	0,83	0,84	1,15	1,48
60	0,252	0,278	0,32	0,36	0,39	0,45	0,52	0,58	0,71	0,84	0,85	1,16	1,49
64	0,265	0,291	0,34	0,37	0,40	0,47	0,53	0,60	0,72	0,85	0,86	1,18	1,50
76	0,30	0,33	0,38	0,41	0,44	0,50	0,57	0,63	0,76	0,89	0,90	1,22	1,54
80	0,32	0,34	0,39	0,42	0,45	0,52	0,58	0,65	0,78	0,91	0,91	1,23	1,55
89	0,35	0,37	0,42	0,45	0,48	0,55	0,61	0,68	0,81	0,93	0,94	1,26	1,58
102	0,39	0,41	0,46	0,49	0,52	0,59	0,65	0,72	0,85	0,98	0,98	1,30	1,62
108	0,41	0,43	0,48	0,51	0,54	0,61	0,67	0,74	0,87	1,00	1,00	1,32	1,64
114	0,43	0,45	0,50	0,53	0,56	0,63	0,69	0,76	0,89	1,02	1,02	1,34	1,66
125	0,46	0,49	0,53	0,57	0,60	0,66	0,73	0,79	0,92	1,05	1,06	1,37	1,70
133	0,49	0,51	0,56	0,59	0,62	0,69	0,75	0,82	0,95	1,08	1,08	1,40	1,72
140	0,51	0,54	0,58	0,61	0,65	0,71	0,78	0,84	0,97	1,10	1,11	1,42	1,75
160	0,58	0,60	0,65	0,68	0,71	0,78	0,84	0,91	1,03	1,16	1,17	1,49	1,81
168	0,60	0,63	0,67	0,71	0,74	0,80	0,87	0,93	1,06	1,19	1,20	1,51	1,84
219	0,77	0,79	0,84	0,87	0,90	0,97	1,03	1,10	1,23	1,36	1,36	1,68	2,00
245	0,85	0,88	0,92	0,95	0,99	1,05	1,12	1,18	1,31	1,44	1,45	1,76	2,09
273	0,94	0,97	1,01	1,04	1,08	1,14	1,21	1,27	1,40	1,53	1,54	1,85	2,18
356	1,21	1,24	1,28	1,31	1,35	1,41	1,47	1,54	1,67	1,80	1,80	2,12	2,45
457	1,54	1,56	1,61	1,64	1,67	1,74	1,80	1,87	2,00	2,12	2,13	2,45	2,77
558	1,86	1,89	1,93	1,97	2,00	2,06	2,13	2,19	2,32	2,45	2,46	2,77	3,10
630	2,10	2,12	2,17	2,20	2,23	2,30	2,36	2,43	2,56	2,68	2,69	3,01	3,33
714	2,37	2,39	2,44	2,47	2,50	2,57	2,63	2,70	2,83	2,96	2,96	3,28	3,60
813	2,69	2,71	2,76	2,79	2,82	2,89	2,95	3,02	3,15	3,28	3,28	3,60	3,92
914	3,01	3,04	3,09	3,12	3,15	3,21	3,28	3,34	3,47	3,60	3,61	3,93	4,25

Pre výpočet dĺžky prírezu PVC fólie alebo iného povrchu je dôležité pripočítať k obvodu na izolácii presah v rozsahu cca 3 až 10cm (v závislosti od typu povrchu).

Príklad: Pre zaizolovanie potrubia Ø 114mm s použitím izolácie hr. 50mm (napr. pre pás šírky 1m), sa použije prírez izolácie dlhý 0,69m.

## Tepelný odpor

Hodnota tepelného odporu ponúka možnosť porovnať energetickú účinnosť izolácie.

**Tepelný odpor "R"** vyjadruje tepelnoizolačné vlastnosti izolácie. Je závislý od hrúbky izolácie (alebo konštrukcie) a súčiniteľa tepelnej vodivosti (lambda  $\lambda$ ), ktorú udáva výrobca.

**Súč. tep. vodivosti  $\lambda$**  vyjadruje vlastnosť materiálu viesť teplo. Je to hodnota energie "W", ktorá prejde materiálom hrúbky 1 "m" pri rozdiel teplôt medzi povrchmi materiálu 1 "K".

Väčšiu hodnotu "R" dosiahneme zvýšením hrúbky izolácie (konštrukcie) alebo voľbou jednotlivých materiálov s čo najnižšou hodnotou " $\lambda$ ".

$$R = d / \lambda \quad [m^2.K.W^{-1}]$$

**R** - je tepelný odpor ( $m^2.K/W$ ) alebo ( $m^2.K.W^{-1}$ )

**d** - hrúbka materiálu (m)

**$\lambda$**  - súčiniteľ tepelnej vodivosti materiálu, udáva ho výrobca ( $W.m^{-1}.K^{-1}$ ) alebo ( $W/m.K$ )

Hrúbka izolácie (mm):	Hodnoty tepelného odporu R																
	v závislosti od súčiniteľa tepelnej vodivosti																
	0,020	0,025	0,030	0,031	0,032	0,033	0,034	0,035	0,036	0,037	0,038	0,039	0,040	0,041	0,042	0,043	0,044
1	0,05	0,04	0,03	0,03	0,03	0,03	0,03	0,03	0,03	0,03	0,03	0,03	0,03	0,02	0,02	0,02	0,02
2	0,10	0,08	0,07	0,06	0,06	0,06	0,06	0,06	0,06	0,05	0,05	0,05	0,05	0,05	0,05	0,05	0,05
5	0,25	0,20	0,17	0,16	0,16	0,15	0,15	0,14	0,14	0,14	0,13	0,13	0,13	0,12	0,12	0,12	0,11
9	0,45	0,36	0,30	0,29	0,28	0,27	0,26	0,26	0,25	0,24	0,24	0,23	0,23	0,22	0,21	0,21	0,20
13	0,65	0,52	0,43	0,42	0,41	0,39	0,38	0,37	0,36	0,35	0,34	0,33	0,33	0,32	0,31	0,30	0,30
15	0,75	0,60	0,50	0,48	0,47	0,45	0,44	0,43	0,42	0,41	0,39	0,38	0,38	0,37	0,36	0,35	0,34
19	0,95	0,76	0,63	0,61	0,59	0,58	0,56	0,54	0,53	0,51	0,50	0,49	0,48	0,46	0,45	0,44	0,43
20	1,00	0,80	0,67	0,65	0,63	0,61	0,59	0,57	0,56	0,54	0,53	0,51	0,50	0,49	0,48	0,47	0,45
25	1,25	1,00	0,83	0,81	0,78	0,76	0,74	0,71	0,69	0,68	0,66	0,64	0,63	0,61	0,60	0,58	0,57
30	1,50	1,20	1,00	0,97	0,94	0,91	0,88	0,86	0,83	0,81	0,79	0,77	0,75	0,73	0,71	0,70	0,68
32	1,60	1,28	1,07	1,03	1,00	0,97	0,94	0,91	0,89	0,86	0,84	0,82	0,80	0,78	0,76	0,74	0,73
40	2,00	1,60	1,33	1,29	1,25	1,21	1,18	1,14	1,11	1,08	1,05	1,03	1,00	0,98	0,95	0,93	0,91
50	2,50	2,00	1,67	1,61	1,56	1,52	1,47	1,43	1,39	1,35	1,32	1,28	1,25	1,22	1,19	1,16	1,14
60	3,00	2,40	2,00	1,94	1,88	1,82	1,76	1,71	1,67	1,62	1,58	1,54	1,50	1,46	1,43	1,40	1,36
70	3,50	2,80	2,33	2,26	2,19	2,12	2,06	2,00	1,94	1,89	1,84	1,79	1,75	1,71	1,67	1,63	1,59
80	4,00	3,20	2,67	2,58	2,50	2,42	2,35	2,29	2,22	2,16	2,11	2,05	2,00	1,95	1,90	1,86	1,82
90	4,50	3,60	3,00	2,90	2,81	2,73	2,65	2,57	2,50	2,43	2,37	2,31	2,25	2,20	2,14	2,09	2,05
100	5,00	4,00	3,33	3,23	3,13	3,03	2,94	2,86	2,78	2,70	2,63	2,56	2,50	2,44	2,38	2,33	2,27
120	6,00	4,80	4,00	3,87	3,75	3,64	3,53	3,43	3,33	3,24	3,16	3,08	3,00	2,93	2,86	2,79	2,73
140	7,00	5,60	4,67	4,52	4,38	4,24	4,12	4,00	3,89	3,78	3,68	3,59	3,50	3,41	3,33	3,26	3,18
160	8,00	6,40	5,33	5,16	5,00	4,85	4,71	4,57	4,44	4,32	4,21	4,10	4,00	3,90	3,81	3,72	3,64
180	9,00	7,20	6,00	5,81	5,63	5,45	5,29	5,14	5,00	4,86	4,74	4,62	4,50	4,39	4,29	4,19	4,09
200	10,00	8,00	6,67	6,45	6,25	6,06	5,88	5,71	5,56	5,41	5,26	5,13	5,00	4,88	4,76	4,65	4,55
220	11,00	8,80	7,33	7,10	6,88	6,67	6,47	6,29	6,11	5,95	5,79	5,64	5,50	5,37	5,24	5,12	5,00
240	12,00	9,60	8,00	7,74	7,50	7,27	7,06	6,86	6,67	6,49	6,32	6,15	6,00	5,85	5,71	5,58	5,45
300	15,00	12,00	10,00	9,68	9,38	9,09	8,82	8,57	8,33	8,11	7,89	7,69	7,50	7,32	7,14	6,98	6,82

Napr. tepelný odpor izolácie s parametrom  $\lambda_{10^\circ C}=0,042$  pri hr.50mm je takmer rovnaký ako pri izolácií s hodnotou  $\lambda_{10^\circ C}=0,034$  v hr.40mm t.j. izolácia s lepšimi tepelnoizolačnými vlastnosťami v menšej hrúbke môže izolovať rovnako ako tepelnoizolačne "horší" materiál s väčšou hrúbkou.

Čím vyššie číslo má tepelný odpor "R" tým lepšie, nakoľko izoláciou (konštrukciou) prejde menej tepla, a teda tým lepšie izolácia znižuje energetické straty. Je dôležité porovnávať hodnoty lambda " $\lambda$ " namerané pri rovnakej teplote. Spravidla sa porovnáva hodnota lambda  $\lambda$ , ktorá zodpovedá prevádzkovej teplote média.

### Návrh hrúbky technických izolácií pre rozvody tepla a teplej vody v budovách:

Technické požiadavky na tepelnú izoláciu rozvodov tepla a teplej vody sa ustanovujú podľa vyhlášky 14/2016 Z.z Ministerstva hospodárstva Slovenskej republiky.

§1 Minimálna hrúbka tepelnej izolácie rozvodov tepla a teplej vody v budovách pre izolačný materiál s tepelnou vodivosťou **0,035 W . m-1.K-1 pri teplote 0 °C**, na oceleťovom potrubí:

P. č	Vnútrotný priemer potrubia alebo armatúry	Minimálna hrúbka izolácie
1	do 22 mm	<b>20 mm</b>
2	od 23 mm do 35 mm	<b>30 mm</b>
3	od 36 mm do 100 mm	<b>rovnaká ako vnútrotný <math>\varnothing</math> potrubia</b>
4	nad 100 mm	<b>100 mm</b>

Pre rozdeľovače a zberače tepla, v miestach križovania potrubí, v miestach spájania potrubí a pre potrubia a armatúry inštalované v prestupoch stien a stropov sa môže minimálna hrúbka izolácie znížiť o 50 % vypočítanej hodnoty hrúbky izolácie.

Hrúbky izolácie sú navrhnuté pre oceleťové potrubie a izoláciu s lambdou 0,035 W /(m.K), pri použití iného materiálu potrubia a izolácie budú vypočítané iné hrúbky izolácie.

### Návrh hrúbky technických izolácií pre rozvody teplej vody a vykurovania:

podľa nemeckého štandardu VDI 2055 (vyhláška o úspore energií EnEV)

Potrubie v palcoch (")	DN potrubia (mm)	Vonk. $\varnothing$ potr. (mm)	Odporúčaná hrúbka izolácie (mm)		
			v závislosti od súčiniteľa tepelnej vodivosti $\lambda$		
			0,035 W/(m·k)	0,040 W/(m·k)	0,045 W/(m·k)
3/8	10	17,2	<b>20</b>	<b>26</b>	<b>34</b>
1,2	15	21,3	<b>20</b>	<b>26</b>	<b>33</b>
3/4	20	26,9	<b>20</b>	<b>25</b>	<b>32</b>
1	25	33,7	<b>30</b>	<b>38</b>	<b>48</b>
1 1/4	32	42,2	<b>36</b>	<b>46</b>	<b>57</b>
1 1/2	40	48,3	<b>42</b>	<b>53</b>	<b>66</b>
2	50	60,3	<b>53</b>	<b>67</b>	<b>83</b>
2 1/2	65	76,1	<b>69</b>	<b>87</b>	<b>107</b>
3	80	88,9	<b>81</b>	<b>102</b>	<b>126</b>
4	100	114,3	<b>100</b>	<b>125</b>	<b>154</b>

### Klasifikácia stavebných výrobkov a prvkov stavieb reakcie na oheň:

Reakcia na oheň je schopnosť výrobku za určitých podmienok prispievať vlastným rozkladom k ohňu, ktorému je vystavený. Základná charakteristika tried:

Trieda **A1** - výrobky, ktoré neprispievajú k požiaru

Trieda **A2** - výrobky, ktoré významne neprispievajú k ďalšiemu rastu požiaru

Trieda **B** - ako pri triede C, ale s prísnejšími požiadavkami

Trieda **C** - ako pri triede D, vykazujúce obmedzené šírenie plameňa

Trieda **D** - ako pri triede E so schopnosťou odolávať pôsobeniu malého plameňa po dlhší čas

Trieda **E** - výrobky schopné odolať pôsobeniu malého plameňa počas krátkočasového intervalu

Trieda **F** - výrobky, ktoré nie je možné zaradiť do žiadnej z predchádzajúcich tried

### Doplnková klasifikácia stavebných výrobkov podľa kritérií:

a.) vývoj dymu:

s3 - žiadne obmedzenia množstva dymu nie je vyžadované

s2 - celkové množstvo dymu je obmedzené

s1 - prísnejšie ako pri s2

b.) plameňom horiace kvapky

d2 - bez obmedzenia

d1 - žiadne kvapky/častice horiace dlhšie ako udáva časový interval

d0 - žiadne plameňom horiace kvapky/častice

Klasifikácia triedy reakcie na oheň podľa STN EN 13501-2010 (pre stavebné výrobky)		Stupeň horľavosti podľa STN 73 0861, STN 73 0862 (pôvodný systém pre stavebné materiály)	
<b>A1</b>	nehorľavé	<b>A</b>	nehorľavé
<b>A2 s1d0</b>		<b>B</b>	neľahko horľavé
<b>ostatné A2, B</b>	horľavé	<b>C1</b>	ťažko horľavé
<b>C</b>		<b>C2</b>	stredne horľavé
<b>D,E</b>		<b>C3</b>	ľahko horľavé
<b>F</b>			

## Najpredávanejšie izolačné tvarovky.

Prehľad najžiadanejších izolačných skruží, ktoré sa používajú na izolovanie ocelových potrubí. Skruže z minerálnej vlny s ALS povrchom a samolepiacim presahom v pozdĺžnom smere v dĺžke 1m typ **Rockwool 800** a 1,2m typ **Paroc Section Alu Coat T**.

Vonk. Ø potr. (mm):	Vnúť. Ø potr. (mm):	Najpoužívannejšie rozmery tvaroviek s ALS fóliou podľa hrúbky izolácie (mm)						
		20	30	40	50	60	80	100
15		15/20						
18	DN15	18/20						
22	DN18	22/20	22/30					
28	DN20	28/20	28/30					
35	DN25	35/20	35/30	35/40				
42	DN35	42/20	42/30	42/40				
48	DN40	48/20	48/30	48/40	48/50			
54			54/30	54/40	54/50			
60	DN50	60/20	60/30	60/40	60/50	60/60		
64			64/30	64/40	64/50			
76	DN65		76/30	76/40	75/50	76/60	76/80	
89	DN80		89/30	89/40	89/50		89/80	
108	DN100		108/30	108/40	108/50			108/100
114					114/50			114/100
133	DN125				133/50			133/100
159	DN150				159/50			159/100
219	DN200				219/50			219/100

## Úspora tepla pri zaizolovanom potrubí (skruže Rockwool 800)

Výpočty boli vykonané pre teplotu média 55 °C a teplotu okolia 18 °C. Úspora je rozdiel medzi neizolovaným potrubím a zaizolovaným potrubím s izolačným púzdom ROCKWOOL 800.

Vonk. Ø potr. (mm):	Úspory tepla pri použití potrubného puzdra ROCKWOOL 800 pre hrúbky izolácie (mm)						
	20	30	40	50	60	80	100
15	75%	79%					
18	77%	80%					
22	78%	81%	84%				
28	79%	83%	85%				
35	80%	84%	86%	87%			
42	81%	84%	86%	88%			
48	81%	85%	87%	88%			
54	81%	85%	87%	89%			
60	82%	85%	88%	89%	90%		
64	82%	85%	88%	89%	90%		
76		86%	88%	89%	90%		
89		86%	88%	90%	91%	92%	93%
108		86%	89%	90%	91%	93%	93%
114		87%	89%	90%	91%	93%	93%
133		87%	89%	90%	91%	93%	94%
159				91%	92%	93%	94%
219				91%			

- hrúbky izolácie podľa vyhlášky 14/2016 Z.z

- väčšie hrúbky izolácie je možné použiť v prípade prísnejšej požiadavky na hrúbku izolácie s cieľom dosiahnuť maximálnu energetickú úsporu atď.

- menšie hrúbky izolácie všade tam, kde to nevyžaduje vyhláška alebo ak nie je možné na potrubie aplikovať izoláciu z dôvodu nedostatku miesta a pod.

# PERINSUL

TEPELNÁ IZOLÁCIA, NA  
KTOREJ MÔŽETE STAVAŤ!

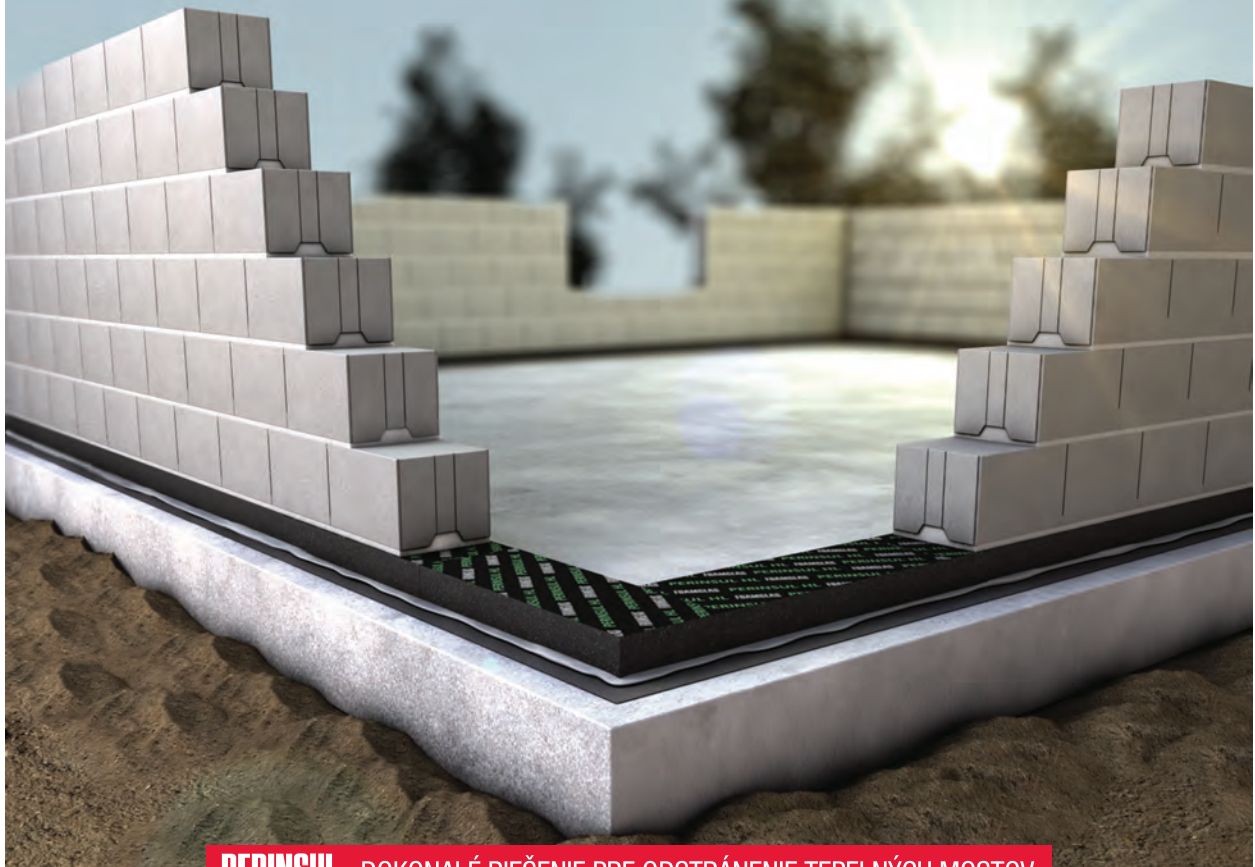

**PERINSUL** - DOKONALÉ RIEŠENIE PRE ODSTRÁNENIE TEPELNÝCH MOSTOV

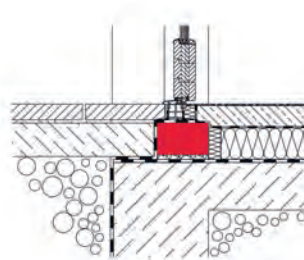
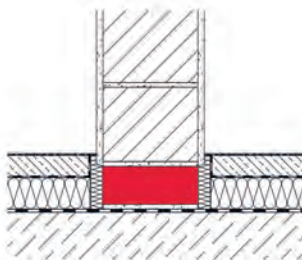
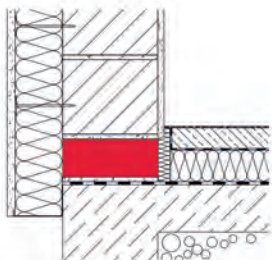



# HELLY HANSEN WORKWEAR

[www.hhww.sk](http://www.hhww.sk)



## ALNA 2.0

Vďaka nažehľeným reflexným prvkom a mäkkým pohodlným látkam je Alna 2.0 ideálnou voľbou pre odolné, pohodlné a moderné pracovné odevy z kolekcie Hi-Vis.



Vrchné bundy s priedušnou a vodeodolnou membránou Helly Tech® Professional.

**HELLY TECH®**  
PROFESSIONAL

Nohavice s dvojcestným strečovým materiálom a výstužami Cordura®.

## CHELSEA EVOLUTION

Elegantné a jednoduché línie dizajnu v kombinácii s progresívnym výberom látok Vám dávajú koncept vytvorený pre budúcnosť.



Vrchné bundy s priedušnou a vodeodolnou membránou Helly Tech® Professional.

**HELLY TECH®**  
PROFESSIONAL

Nohavice so štvorcestnou strečovou textíliou vo vybraných oblastiach a výstužami Cordura®.



## OXFORD

Jedinečná, spoľahlivá a pohodlná: Jedna z našich najpredávanejších kolekcií z bavlnených materiálov.



Vrchné bundy s priedušnou a vodeodolnou membránou Helly Tech® Performance.

**HELLY TECH®**  
PERFORMANCE

Nohavice s obojstranne pružnou textíliou vo vybraných oblastiach a nylonovými výstužami.



## **OBCHODNÉ PODMIENKY:**

---

- Ceny sú v EUR bez DPH, platné v čase vydania cenníka.
- Platnosť cenníka: do vydania novej verzie cenníka.
- Aktuálne veľkoobchodné cenníky sú dostupné na prevádzkach AZ FLEX, s.r.o. alebo k stiahnutiu na: <http://www.azflex.sk>
- Ceny v cenníku sú platné pre odbery, ktoré je možné zrealizovať s termínom dodania do konca platnosti cenníka.
- Izolácie s dlhším dodacím termínom budú dodávané v cenách podľa nových podmienok stanovené výrobcom.
- Všeobecné obchodné podmienky AZ FLEX, s.r.o.:  
<http://www.azflex.sk/vseobecne-obchodne-podmienky/>
- Predávajúci si vyhradzuje právo zmeniť ceny a výšku zliav v prípade zmeny nákupných alebo dovozných podmienok.



■ **AZ FLEX®**



# AZ FLEX®

**AZ FLEX, s.r.o.**

**Štrková 968/10C**

**010 09 Žilina-Bytčica**

- **web:** [www.azflex.sk](http://www.azflex.sk)
- **IČO:** 36422851
- **IČ-DPH:** SK2021876032
- **Banka:** Československá obchodná banka, a.s. Žilina
- **SWIFT:** CEKOSKBX
- **Číslo účtu:** 4019665166/7500
- **IBAN:** SK83 7500 0000 0040 1966 5166
- **Výpis z OR:** Okresný súd Žilina, oddiel Sro, vložka č.15429/L



## PREDAJNÁ DOBA:

- **PONDELOK – PIATOK:**  
7:30 - 16:00 hod.

## ÚČTOVNÉ ODDELENIE:

- **Mgr. Tatiana Adamcová**  
☎ +421 911 944 296  
✉ [azflex@azflex.sk](mailto:azflex@azflex.sk)

## PREVÁDZKA ŽILINA:

- 📍 AZ FLEX s.r.o.,  
Štrková 968/10C  
010 01 Žilina

### Oddelenie odbytu

- ✉ [zilina@azflex.sk](mailto:zilina@azflex.sk)  
Zuzana Kováčová  
☎ +421 910 944 298  
Marko Fondati  
☎ +421 910 944 297

### Technické a obchodné oddelenie

- ✉ [sustek@azflex.sk](mailto:sustek@azflex.sk)  
Marián Šustek  
☎ +421 911 944 297

## PREVÁDZKA KOŠICE:

- 📍 AZ FLEX s.r.o.,  
Rampová 5  
040 01 Košice

### Oddelenie odbytu

- ✉ [kosice@azflex.sk](mailto:kosice@azflex.sk)  
Peter Tivadar  
☎ +421 911 944 289  
Soňa Halászová  
☎ +421 915 110 040

### Technické a obchodné oddelenie

- ✉ [gladic@azflex.sk](mailto:gladic@azflex.sk)  
Miroslav Gladič  
☎ +421 911 944 288

## PREVÁDZKA BRATISLAVA:

- 📍 AZ FLEX s.r.o.,  
Stavitelská 7  
831 04 Bratislava

### Oddelenie odbytu

- ✉ [bratislava@azflex.sk](mailto:bratislava@azflex.sk)  
Jaroslav Fečko  
☎ +421 911 944 294  
Andrej Tománek  
☎ +421 911 944 295

### Technické a obchodné oddelenie

- ✉ [sustek@azflex.sk](mailto:sustek@azflex.sk)  
Marián Šustek  
☎ +421 911 944 297



# **AZ FLEX<sup>®</sup>**



[www.azflex.sk](http://www.azflex.sk)



[www.azflex.cz](http://www.azflex.cz)

